

Ingeteam

INGESYS™ IC2

Product Overview



Table of Contents

1	Introduction	7
2	Hardware Description	9
2.1	Power Supply	11
2.1.1	24Vdc	11
2.1.2	72-110Vdc	11
2.2	Processor Module	12
2.3	Header Module	15
2.3.1	Header module CAN	15
2.3.2	Header module RTSX	16
2.4	Communications Modules	17
2.4.1	Fieldbuses interfaces	17
2.4.1.1	CAN interface module	17
2.4.1.1.1	Copper (CAN)	18
2.4.1.1.2	Fiber (CAN FO)	19
2.4.1.2	MVB interface module	19
2.4.1.2.1	MVB ESD+ interface module	19
2.4.1.2.2	MVB EMD interface module	20
2.4.1.2.3	MVB EMD-R module	21
2.4.1.2.4	MVB EMD SNFR module	21
2.4.1.3	PROFIBUS-DP interface module	22
2.4.1.4	PROFINET I/O interface module	23
2.4.2	ETHERNET communications module	24
2.4.3	SERIAL communications module	25
2.4.3.1	RS232/RS485	25
2.4.3.2	RS485-T	26
2.4.4	WIRELESS interfaces	26
2.4.4.1	GSM interface module	27
2.4.4.2	WiFi interface module	27
2.5	User Interface Modules	27
2.5.1	ROTARY SWITCH	27
2.5.2	DISPLAY	28
2.6	Input /Output's Modules	28
2.6.1	Digital Modules	30
2.6.1.1	16 Digital Input	30
2.6.1.2	4 Digital Input 2 Fast Digital Input	31
2.6.1.3	16 NPN Digital Input	32

2.6.1.4	16 Digital Output	34
2.6.1.5	8 2A Digital Output	35
2.6.1.6	16 NPN Digital Output	36
2.6.1.7	8 Digital Input 8 Digital Output	37
2.6.1.8	12 Digital Input 4 Digital Output	39
2.6.1.9	4 Digital Input 12 Digital Output	41
2.6.1.10	3 Relay Output	42
2.6.2	Analog Modules	43
2.6.2.1	8 Analog Input	43
2.6.2.2	4IEPE 4 Fast Analog Input	44
2.6.2.3	6IEPE 2 Fast Analog Input	46
2.6.2.4	10 Temperature Input	47
2.6.2.5	4 Analog Output	49
2.6.3	Specific Function Modules	50
2.6.3.1	DC Motor Control module	50
2.6.3.1.1	DC Motor Control	50
2.6.3.1.2	High Power DC Motor Control	52
2.6.3.2	Audio Output module	54
2.6.3.3	Condition Monitoring	54
2.6.3.3.1	Basic	55
2.6.3.3.2	Advanced	57
3	Software Description	61
4	Mechanical Solution	63
4.1	System Configuration	64
4.2	Mechanical Data	65
5	Use Conditions & Standards	67
5.1	Climatic	68
5.2	Storage and Transport	68
5.3	Electromagnetic Compatibility	69
5.4	Vibration and Shock	70
5.5	Fire Protection	71
5.6	Cabling	71
6	INGESYS™ IC2 Selection Table	73
7	Revisions	77

Introduction

1 Introduction

INGESYS™ IC2 is a standalone Controller with an internal modular and expandable design, oriented to fulfill the requirements of control applications demanding a reduced number of digital/analog I/Os, IEC61131 standard based programmable languages, wide range of communication interfaces and remote monitoring features based on an embedded Web server.

INGESYS™ IC2 offers two variants each one with specific characteristics for the target application sector:

- Variant for the Rolling stock control in the railway sector.

This variant identified by the code R in the product reference code (IC2-X-R-XXXX) has specific hardware characteristics demanded for rolling stock control system

- Variant for the rest of industrial sectors (Industry, Energy, etc.)

This variant identified by the code I in the product reference code (IC2-X-I-XXXX) has specific hardware characteristics demanded for general control systems.

Easy integration in control networks is possible thanks to its wide range of communication interfaces, for integration in LAN networks via ETHERNET with protocols as MODBUS TCP/IP, ETHERNET IP/CIP, TRDP and in fieldbuses like CAN, MVB, PROFIBUS DP, RS485, PROFINET I/O-Device RT.

Hardware Description

2 Hardware Description

INGESYS™ IC2 has a modular and expandable design that permits to achieve an optimal hardware solution for each application.

Two control topologies are available:

- Centralized topology

In this topology the Controller is integrated by a single central system that incorporates a processor module and up to 10 I/O modules in a compact mechanical enclosure

- Distributed topology

In this topology the Controller is integrated by the central system expanded with up to 16 Remote I/Os units connected by a CAN fieldbus.

Remote I/O units are integrated by a header module and up to 8 I/O modules in a compact mechanical enclosure.

Based on application requirements, the user determines the specific components that will constitute the automation system, considering the most general architecture, central units (Processor+Power supply+ Communications+I/Os) and Remote I/O units (Headers+Power Supply+I/Os). After having defined exactly the components for the Central and Remote I/O units a compact mechanical enclosure with a unique reference is assigned to each of these units.

Main components of **INGESYS™ IC2** are described in following sections.

2.1 Power Supply

Two possible power supply modules are available for 24Vdc or 72-110Vdc voltages, each one for two specific sector: Industrial or Rolling Stock - Railway .

Main characteristics of these power supply modules are:

2.1.1 24Vdc

Power Supply		
Electrical		
Sector:	R (Rolling Stock)	I (Industrial)
Power Supply Voltage	24Vdc (-30%/+25%) Class S1/C1 (EN50155:2017)	24Vdc (-20%/+25%)
Maximum Power Supply Consumption	600mA@24V	
Dissipated Power	8W (max.)	

Tbl 1. Power Supply. 24Vdc Technical Data.

2.1.2 72-110Vdc

Power Supply		
Electrical		
Sector:	R (Rolling Stock)	I (Industrial)
Power Supply Voltage	72-110Vdc (-30%/+25%) Class S2/C1 (EN50155:2017)	72-110Vdc (-20%/+25%)
Maximum Power Supply Consumption	200mA@72V	
Dissipated Power	8W (max.)	

Tbl 2. Power Supply. 72-110Vdc Technical Data.

Connector pinout is as follows:

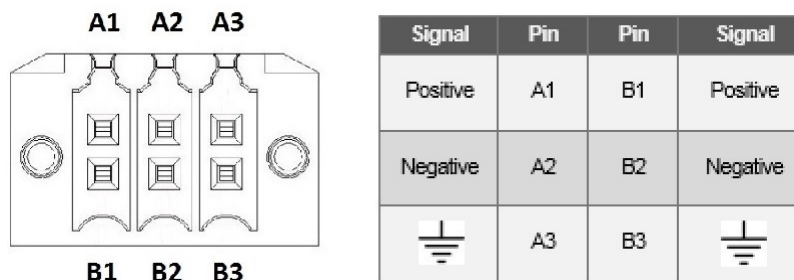

Fig 1. Power supply connector.

Note:

(A1-B1), (A2- B2), (A3- B3) internally tied.

2.2 Processor Module

INGESYS™ IC2 offers different processor module types, IC2-C, IC2-HC, IC2-HCS, IC2-PC and IC2-PCS that share some common characteristics but at the same time offer specific properties in aspects like: data and program memory, communications, programming tools, logging and Webserver capabilities.

Common and specific characteristics of these processor modules are described in following table:

Common processor characteristics		
Functional		
Sector:	R (Rolling Stock)	I (Industrial)
Communication ports connectors	M12 4 pin D-Code connector	RJ45 connector
USB interface	1USB 2.0 Type A	

Tbl 3. Common processor characteristics.

Specific processor characteristics			
	IC2-C-xxx	IC2-HC-xxx	IC2-HCS-xxx
Main CPU	32bit processor 400MHz		
Data memory	512Kbyte	1Mbyte	
Program memory	1Mbyte	1Mbyte	
Retain variable	512	1.024	
Retain memory	30Kbyte	62Kbyte	
Memory %Q	200Kbyte		
Memory %I	12Kbyte		
Memory %M	1Kbyte		
Programming Tools			
IEC61131	Yes		
C , C++	Yes		
MATLAB®/Simulink®	No	Yes	
Datalogger			
Registrable variables	256	1.024	
Consecutive recordings	8	32	
Max. number of registrable variables in a recording configuration	32	64	
Recording buffer	8Kbyte	512Kbyte	
Simultaneous recordings	1	2	
Max. number of recording configurations	4	32	
WEB Interface			
WEB / GSV user variables	2.048	4.096	
WEB Alarms	512	1.024	
Max. number of simultaneous client connections	2	5	

Historical Data		
Max. Number of data changes	3.072	12.288
Max. Number of alarms	1.536	3.072
Communication ports		
Communication ports	2 x 10/100-Base-TX (Internal Switch) ETHERNET ports	
Communication Interfaces		
Available fieldbus ports	2	4
Max. number of CAN ¹ slaves per CAN master interface	4	32
ETHERNET ports	-	Optional: 1 Extra ² ETHERNET port
ETHERNET Protocols		
ETHERNET IP/CIP	Yes	
TRDP	Yes	
MODBUS TCP/IP	Yes	
Srv: Max conexions with clts	6	32
Clit: Max conexions with srvs	6	48
Storage Memory		
Internal	32Mbyte	
Expansion Internal up to:	-	1, 2, 4 Gbyte ³

Tbl 4. Specific processor characteristics.

- ¹ Only applicable when at least one CAN port has been selected
- ² Extra independent ETHERNET port, selectable in commercial reference
- ³ Selectable in commercial reference

Specific processor characteristics		
	IC2-PC-xxx	IC2-PCS-xxx
Main CPU	32bit Dual Core 800Mhz	
Data memory	up to 4Mbyte	
Program memory	4Mbyte	
Retain memory	128Kbyte	
Programming Tools		
IEC61131	Yes	
C , C++	Yes	
MATLAB®/Simulink®	No	Yes
Communication Ports		
Communication Ports	2 x 10/100-Base-TX ETHERNET ports	
Communication Interfaces		
Available fieldbus ports	4	
ETHERNET Protocols		
MODBUS TCP/IP	Yes	

Tbl 5. Specific processor characteristics.

Status LED:

LED	INDICATION	LED COLOUR
Power	Controller powered	Red
	Controller no powered	OFF
ON	Controller ON	Green
	Controller without FW	Green Blinking (T=3")
OK	Controller OK	Green
	No User Application	OFF
OKIO	Inputs / Outputs OK	Green
	Inputs / Outputs Error	OFF
RUN	Controller Running	Green Blinking
	Controller Stopped	OFF
BUSY	Controller Busy (Firmware Updating)	Blue

Tbl 6. Processor module status LEDs.

2.3 Header Module

Header modules enable the integration of inputs / outputs modules in a distributed Remote I/O unit. Remote I/O units are accessed by the main processor through an expansion bus.

This bus can be:

- CAN
- RTSX

2.3.1 Header module CAN

CAN Remote I/O units are accessed by the main processor through the CAN expansion bus, in each CAN bus is possible to connect up to 16 Remote I/O units.

Parameter configuration and EDS file generation is made by the internal Web server included in the header module.

Main characteristics of these header modules are:

CAN Header module characteristics		
Function		
Sector:	R (Rolling Stock)	I (Industrial)
Configuration ports connectors	M12 4pin D-Code connector	RJ45 connector
Configuration ports	2 ETHERNET x 10/100-Base-TX (Internal Switch) ¹	
USB interface	1USB 2.0 Type A	
Max. number of I/O modules per header	8	
Fieldbus	CAN	
CAN ports	1	

Tbl 7. CAN Header module characteristics.

¹ System configuration via WEB Server

The CAN header module has six status LEDs:

LED	INDICATION	LED COLOUR
Power	Remote I/O powered	Red
ON	Remote I/O ON	Green
	Remote I/O without FW	Green Blinking (T=3")
OK	Remote I/O configuration OK	Green
	Remote I/O configuration Error	OFF
OKIO	Inputs / Outputs OK	Green
	Inputs / Outputs Error	OFF
RUN	Remote I/O in OPERATIONAL state	ON
	Remote I/O in PRE-OPERATIONAL state	Green Blinking
	Remote I/O CAN BUS OFF state	OFF
BUSY	Remote I/O Busy (Firmware Updating)	Blue

Tbl 8. CAN Header module status LEDs.

2.3.2 Header module RTSX

RTSX Remote I/O units are accessed by the main processor through the RTSX expansion bus. In this bus is possible to connect up to 8 Remote I/O units.

Parameter configuration is made in the main program, similar to parameter configuration of local I/Os, adding a configuration file provided for each header module reference.

Main characteristics of these header modules are:

RTSX Header module characteristics	
Function	
Max. number of I/O modules per header	8
Fieldbus	RTSX
RTSX ports	1 (single connection), 2 (Daisy chain connection)

Tbl 9. RTSX Header module characteristics.

The RTSX header module has four status LEDs:

LED	INDICATION	LED COLOUR
Power	Remote I/O powered	Red
ON	Remote I/O ON	Green
	Remote I/O internal Error	OFF
OK	Remote I/O communication OK	Green
	Remote I/O communication Error	OFF
OKIO	Inputs / Outputs OK	Green
	Inputs / Outputs Error	OFF

Tbl 10. RTSX Header module status LEDs.

2.4 Communications Modules

The interface modules that can be integrated in an **INGESYS™ IC2** are resumed in following table:

Type	Interface Module
Fieldbuses	CAN: CAN: Copper CAN FO: Fiber MVB (Multi function vehicle bus): MVB ESD+: Electrical Short Distance Plus MVB EMD: Electrical Medium Distance MVB EMD-R : Electrical Medium Distance (128 ports) MVB EMD SNFR : Electrical Medium Distance (sniffer) PROFIBUS-DP: Slave PROFINET: Profinet I/O-Device RT
Ethernet	10/100 Mbit/s. Protocols: MODBUS TCP/IP, ETHERNET IP/CIP, TRDP, RAW
Serial	RS232/485: 1 port Protocols: MODBUS TCP/IP, ETHERNET IP/CIP, TRDP, RAW RS485-T: 2 port (internal T connection) Protocols: MODBUS TCP/IP, ETHERNET IP/CIP, TRDP, RAW
Wireless	GSM: 3G & 4G Modem WiFi: 802.11n

Tbl 11. INGESYS™ IC2 interface modules.

2.4.1 Fieldbuses interfaces

In the case of fieldbus based communications, the **INGESYS™ IC2** enables the user the selection of different hardware interface modules, currently available are CAN (Master/Slave), MVB, PROFIBUS-DP, RS232/485, PROFINET I/O-Device RT.

In the case of C type processors up to two fieldbus interfaces can be integrated, for HC/HCS type processors up to four fieldbus interfaces can be integrated.

Main characteristics of these fieldbus interfaces are described in following sections:

2.4.1.1 CAN interface module

There are two available CAN interface modules depending on the desired transmission media: cable or fiber optic.

2.4.1.1.1 Copper (CAN)

Main characteristics:

Communications	
Communication Protocol	CANopen (Master/Slave)
Number of channels	1
Connection type	9-pin D-sub male (4-40 UNC screw locks)
Galvanic isolation	500Vdc between field signals and internal logic
Physical medium	Copper
Maximum Transmission speed	Up to 1Mbit/s (Cable length dependent)

Tbl 12. CAN cable interface module characteristics.

Connectors pinout is as follows:

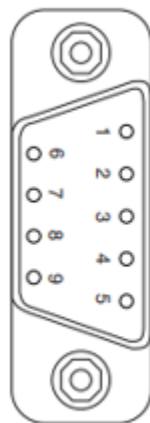

CAN	
1	R_Term *
2	CANL
3	GND
4	
5	⏏
6	R_Term*
7	CANH
8	
9	

Tbl 13. CAN cable interface connector pinout.

Note:

(*) short circuit for connecting bus end resistor

2.4.1.1.2 Fiber (CAN FO)

Main characteristics:

Communications	
Communication Protocol	CANopen (Master/Slave)
Number of channels	1
Connection type	Versatile Link (fiber optic)
Physical medium	POF, HCS
Maximum Transmission speed	Up to 1Mbit/s

Tbl 14. CAN fiber optic interface characteristics.

Connectors pinout is as follows:

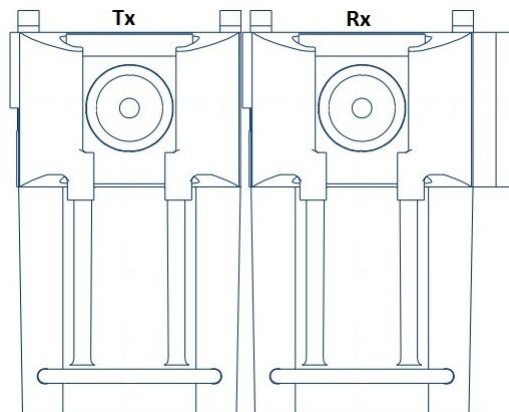

CAN FO	
Left	Tx
Right	Rx

Tbl 15. CAN fiber optic interface connector pinout.

2.4.1.2 MVB interface module

There are four available MVB interface modules depending on the desired electrical distance.

2.4.1.2.1 MVB ESD+ interface module

In the case of MVB communication bus, the **INGESYS™ IC2** behaves as a MVB Class 1 device with up to 16 ports configurable as input or output.

Main characteristics:

Communications	
Communication Protocol	MVB
Number of channels	2
Connection type	1 x 9-pin D-sub female (M3 screw locks) 1 x 9-pin D-sub male (M3 screw locks)
Galvanic isolation	500Vdc between field signals and internal logic
Physical medium	ESD+
Maximum Transmission speed	1,5Mbit/s

Tbl 16. MVB ESD+ interface module characteristics.

Connectors pinout is as follows:

Pin	Signal
1	A.Data_P
2	A.Data_N
3	-
4	B.Data_P
5	B.Data_N
6	A.Bus_GND
7	B.Bus_GND
8	A.Bus_5V
9	B.Bus_5V

Fig 2. MVB ESD+ interface module connector pinout.

2.4.1.2.2 MVB EMD interface module

In the case of MVB communication bus, the **INGESYS™ IC2** behaves as a MVB Class 1 device with up to 16 ports configurable as input or output.

Main characteristics:

Communications	
Communication Protocol	MVB
Number of channels	2
Connection type	1 x 9-pin D-sub female (M3 screw locks) 1 x 9-pin D-sub male (M3 screw locks)
Galvanic isolation	500Vdc between field signals and internal logic
Physical medium	EMD
Maximum Transmission speed	1,5Mbit/s

Tbl 17. MVB EMD interface module characteristics.

Connectors pinout is as follows:

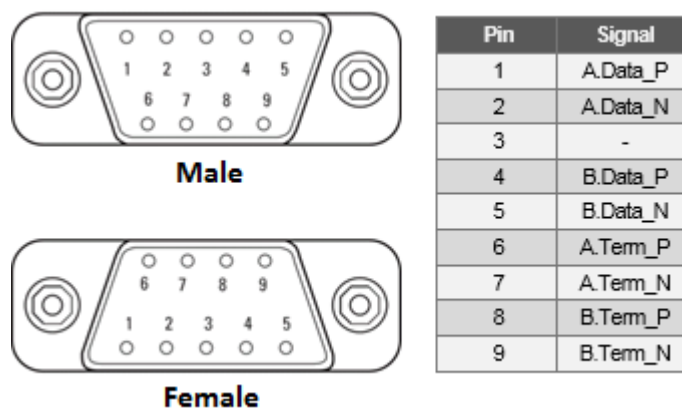

Fig 3. MVB EMD interface module connector pinout.

2.4.1.2.3 MVB EMD-R module

In the case of MVB communication bus, the **INGESYS™ IC2** behaves as a MVB Class 1 device with up to 128 ports configurable as input or output.

Main characteristics:

Communications	
Communication Protocol	MVB
Number of channels	2
Connection type	1 x 9-pin D-sub female (M3 screw locks) 1 x 9-pin D-sub male (M3 screw locks)
Galvanic isolation	500Vdc between field signals and internal logic
Physical medium	EMD
Maximum Transmission speed	1,5Mbit/s

Tbl 18. MVB EMD-R interface module characteristics.

Connectors pinout is as follows:

Pin	Signal
1	A.Data_P
2	A.Data_N
3	-
4	B.Data_P
5	B.Data_N
6	A.Term_P
7	A.Term_N
8	B.Term_P
9	B.Term_N

Fig 4. MVB EMD-R interface module connector pinout.

2.4.1.2.4 MVB EMD SNFR module

Enables the **INGESYS™ IC2** to behave as a MVB Sniffer capable of reading up to 4096 ports on the MVB bus.

Main characteristics:

Communications	
Communication Protocol	MVB
Number of channels	2
Connection type	1 x 9-pin D-sub female (M3 screw locks) 1 x 9-pin D-sub male (M3 screw locks)
Galvanic isolation	500Vdc between field signals and internal logic
Physical medium	EMD
Maximum Transmission speed	1,5Mbit/s
Functionality	Sniffer

Tbl 19. MVB EMD SNFR interface module characteristics.

Connectors pinout is as follows:

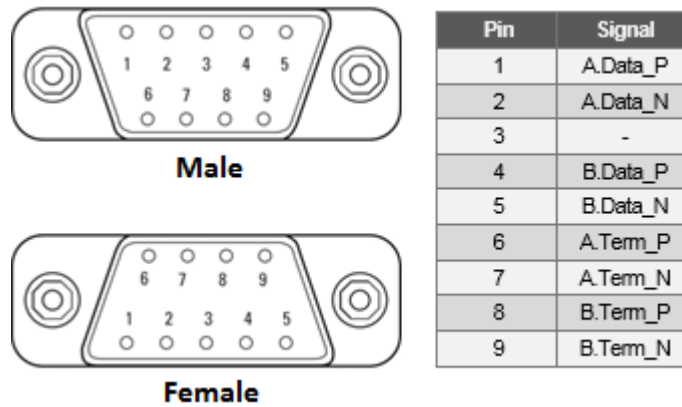

Fig 5. MVB EMD interface module connector pinout.

2.4.1.3 PROFIBUS-DP interface module

In the case of PROFIBUS-DP communication bus, the **INGESYS™ IC2** behaves as a slave.

Main characteristics:

Communications	
Communication Protocol	PROFIBUS-DP Slave
Number of channels	1
Connection type	9-pin D-sub female (4-40 UNC screw locks)
Physical medium	Copper
Maximum Transmission speed	Up to 12Mbit/s

Tbl 20. PROFIBUS DP interface module characteristics.

Connectors pinout is as follows:

	P-DP
1	
2	
3	B
4	RTS
5	GND
6	
7	
8	A
9	

Fig 6. PROFIBUS DP interface module connector pinout.

2.4.1.4 PROFINET I/O interface module

Main characteristics:

Communications	
Communication Protocol	PROFINET I/O-Device RT (class B)
Connection type	<ul style="list-style-type: none"> Sector Railway : 2 x M12 4pin D-Code connector (Internal Switch) (X24 P1 , X24 P2) Sector Industrial : 2 x RJ45 connector (Internal Switch) (X24 P1 , X24 P2)
Physical medium	Copper
Maximum Transmission speed	100 Mbit/s

Tbl 21. PROFINET RT S interface module characteristics.

Connectors pinout is as follows:

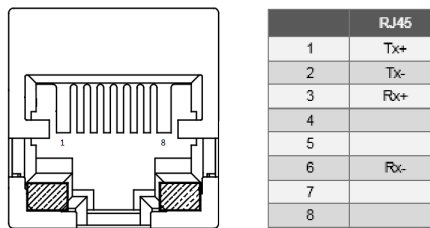

Fig 7. PROFINET RT S Connector.

Status LEDs.

LED	INDICATION	LED COLOUR
Link status	Inactive Link	Green
	No Link	OFF
	Active Link	Green Blinking
Link Speed	100Mbps/s speed	Orange
	10Mbps/s speed	OFF

Tbl 22. PROFINET RT S status LEDs.

Module status LEDs:

LED	INDICATION	LED COLOUR
Network Status	Online (RUN)	Green
	Offline	OFF
	Online (STOP)	Green, 1 flash
	Used by engineering tools to identify the node on the network	Green, blinking
	Major internal error	Red
	Station name not set	Red, 1 flash
	IP address not set	Red, 2 flashes
	Expected identification differs from Real Identification	Red, 3 flashes
Module Status	Normal operation	Green
	Not initialized	OFF
	Diagnostic event(s)	Green, 1 flash

	Exceptional error	Red
	Fatal Event	
	Firmware Update	Alternating Red/Green

Tbl 23. PROFINET RT S Network and Module status LEDs.

2.4.2 ETHERNET communications module

For ETHERNET based communication the **INGESYS™ IC2** incorporates 2 ports internally switch and as an option, in the case of processors type IC2-HC-xxx and IC2-HCS-xxx, an additional ETHERNET port with own IP address can be added.

Available ETHERNET protocols are the following: MODBUS TCP/IP, ETHERNET IP/CIP, TRDP.

	IC2-C-xxx	IC2-HC-xxx	IC2-HCS-xxx
ETHERNET ports	2 ports (internal switch)		
Optional ETHERNET ports	-	1 Extra ¹ ETHERNET port	
Physical medium	Copper		
Connection type	<ul style="list-style-type: none"> • Sector R : M12 4 pin D-coded connector • Sector I : RJ45 connector 		
Maximum Transmission speed	10/100 Mbit/s		

Tbl 24. ETHERNET characteristics.

¹ Extra independent ETHERNET port, selectable in commercial reference

M12 connectors pinout is as follows:

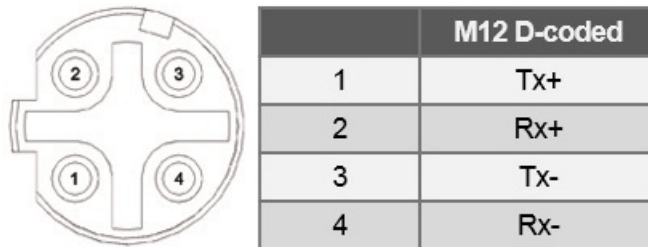

Fig 8. ETHERNET Connector.

RJ45 connectors pinout is as follows:

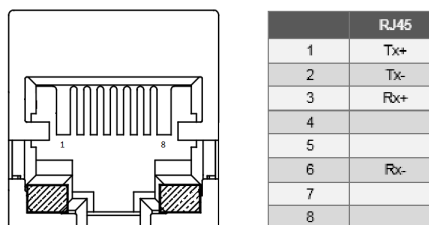

Fig 9. ETHERNET Connector.

Status LEDs.

LED	INDICATION	LED COLOUR
Link status	Inactive Link	Green
	No Link	OFF

	Active Link	Green Blinking
Link Speed	100Mbps/s speed	Orange
	10Mbps/s speed	OFF

Tbl 25. ETHERNET status LEDs.

2.4.3 SERIAL communications module

There are two available SERIAL communications interface modules depending on the buses:

2.4.3.1 RS232/RS485

INGESYS™ IC2 can be integrated in RS232/RS485 communications buses.

Main characteristics:

Communications	
Protocols	MODBUS RTU, Transparent protocol
Number of ports	1
Connection type	9-pin D-sub male (4-40 UNC screw locks)
Galvanic isolation	500Vdc between field signals and internal logic
Physical medium	Copper
Maximum Transmission speed	RS232 Up to 64Kbit/s cable length dependent RS485 Up to 500Kbit/s cable length dependent
Signals/Diagnosis	Yes

Tbl 26. RS232/RS485 characteristics.

Connectors pinout is as follows:

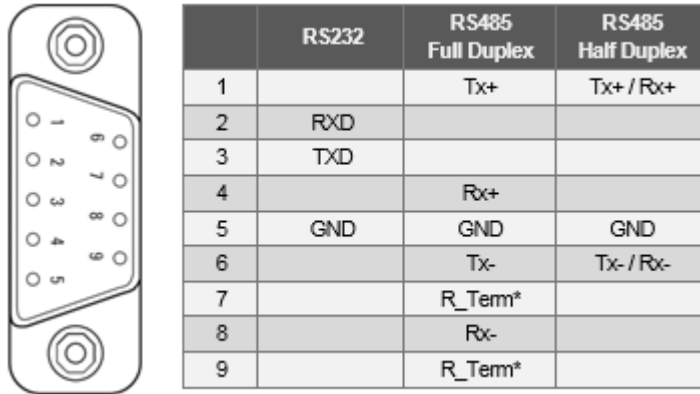

Fig 10. RS232/485 connector pinout.

Note:

To enable terminating resistor integrated in the card 1 or 2 bridges are needed depending on whether it is 2 wire (Half Duplex) or 4 wire (Full Duplex) connection.

HALF

1 – 4

6 – 7

FULL

7 - 9

(*) indicates pins for bus end resistor

2.4.3.2 RS485-T

INGESYS™ IC2 can be integrated in RS485 communications buses.

Main characteristics:

Communications	
Protocols	MODBUS RTU, Transparent protocol
Number of ports	2 ports (internally bypassed)
Connection type	9-pin D-sub female (4-40 UNC screw locks), connector X20 9-pin D-sub male (4-40 UNC screw locks), connector X22
Galvanic isolation	500Vdc between field signals and internal logic
Physical medium	Copper
Maximum Transmission speed	RS485 Up to 500Kbit/s cable length dependent
Signals/Diagnosis	Yes

Tbl 27. RS485 characteristics.

Connectors pinout is as follows:

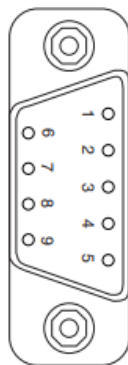

	RS485 Full Duplex	RS485 Half Duplex
1	Tx+	Tx+ / Rx+
2		
3		
4	Rx+	
5	GND	GND
6	Tx-	Tx- / Rx-
7		
8	Rx-	
9		

Fig 11. RS485-T connector pinout.

Note:

When this equipment is the first or the last one in the bus, there is a series terminating resistor integrated in the card that can be connected. 1 or 2 bridges are needed on the spare connector depending on whether it is 2 wire (Half Duplex) or 4 wire (Full Duplex) connection.

HALF (These bridges should be done in free connector)

1 – 4

6 – 7

FULL (This bridge should be done in free connector)

7 - 9

2.4.4 WIRELESS interfaces

INGESYS™ IC2 can be integrated in GSM and WiFi fieldbuses.

2.4.4.1 GSM interface module

INGESYS™ IC2 can be integrated via GSM communications links to centralized Analysis and Monitoring centers.

Main characteristics:

Communications	
Functional	
Standards	UMTS/HSPA+ (3G) GSM/EDGE (2G)
Frequencies	UMTS: 800/ 850/ 900/ 1900/ 2100MHz GSM/EDGE: 850/ 900/1800/ 1900MHz
Sensitivity	UMTS: -110dBm GSM850/EGSM900: -108.5dBm DCS1800/PCS1900: -108dBm
Antenna connector	SMA female (Connector: X21)
SIM Card format	MicroSIM

Tbl 28. GSM characteristics.

2.4.4.2 WiFi interface module

INGESYS™ IC2 can be integrated via WLAN communications links to centralized Analysis and Monitoring centers.

Main characteristics:

Communications	
Functional	
Standards	Dual-band Wi-Fi (802.11 a/b/g/n)
Working mode	Client mode AP mode
Frequency Band	2.412 - 2.484 GHz (20Mhz channels) 5.180 - 5.845 GHz (20 and 40Mhz channels)
Supported Data Rates	802.11abg data rates up to 54 Mbps 802.11n data rates up to MCS7
Modulation	OFDM with BPSK, QPSK, 16-QAM, 64-QAM IEEE 801.11b with CCK and DSSS
802.11 MAC Features	WEP, WPA, WPA2, WMM, WMM-PS (UAPSD), WMM-SA, AES, TKIP, CKIP
Antenna connector	SMA female reverse polarity (Connector: X23)

Tbl 29. WLAN characteristics.

2.5 User Interface Modules

2.5.1 ROTARY SWITCH

Main characteristics:

Communications	
Number of Rotary switch	2
Number of Position (each switch)	16

Tbl 30. Rotary switch interface module characteristics.

Connector is as follows:

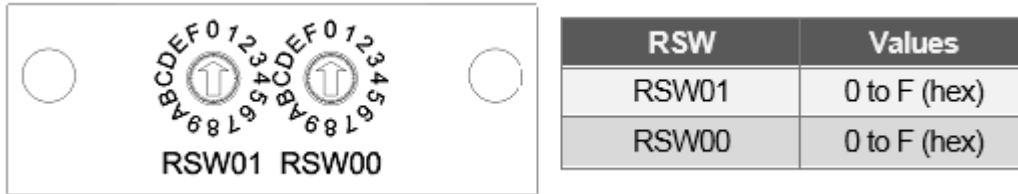

Fig 12. Rotary switch interface module connector.

2.5.2 DISPLAY

Main characteristics:

LCD Character Display	
Lines	2
Characters	16
Backlight	Yes
Buttons	3 general purpose

Tbl 31. LCD interface module characteristics.

LCD is as follows:



Fig 13. LCD interface module.

2.6 Input /Output's Modules

Following Input/Outputs modules can be integrated in an **INGESYS™ IC2**:

Type	I/O Module
Digital Inputs	16 digital inputs 4 digital inputs 2 fast digital inputs 16 NPN 0.25A digital inputs
Digital Outputs	16 digital outputs 8 2A digital outputs 16 NPN 0.25A digital outputs
Digital Inputs / Outputs	8 digital inputs 8 digital outputs 12 digital inputs 4 digital outputs 4 digital inputs 12 digital outputs
Relay Output	3 Relay outputs: Electromechanical relay
Analog Inputs	8 analog inputs 4 IEPE inputs 4 fast analog inputs 6 IEPE inputs 2 fast analog inputs 10 Temperature inputs: PT100, NTC and TC sensors

Analog Outputs	4 analog outputs
DC Motor control	DC Motor Control: 1 PWM H bridge 4A output 1 x encoder input 4 x digital inputs High Power DC Motor Control: 1 PWM H bridge 12A output 1 x encoder input 4 x digital inputs
Audio	Audio output: 2 audio channels with internal memory
Condition Monitoring	Basic: 4 IEPE inputs 1 x encoder input 1 analog inputs Advanced: 8IEPE input 6 Digital input 2 Digital output 2 Analog input 2

Tbl 32. INGESYS™ IC2 modules.

2.6.1 Digital Modules

2.6.1.1 16 Digital Input

Digital input module with 16 x 24Vdc inputs with common reference.

Main characteristics:

Digital Inputs	
Functional	
Number of inputs	16
Connection mode	One common return
Input polarity	Positive (type PNP)
Input delay time	0.5ms (max.)
Electrical	
Input to system isolation	2500Vdc, 60s
Isolation between inputs	No
Nominal voltage	24Vdc
Low level	0V to 11V
High level	16,8V to 30V
Input current	3mA (typ.) @ 24V

Tbl 33. Digital Inputs. Technical Data.

Connector and pinout is as follows:

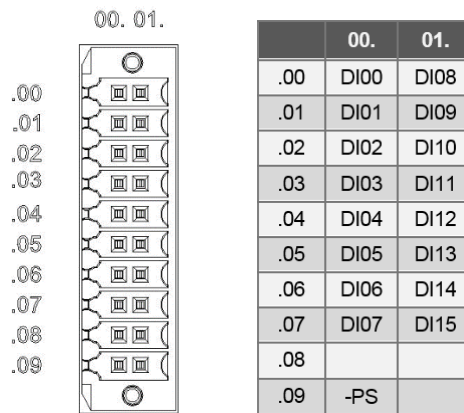

Fig 14. Digital Input connector and pinout.

Note:

External circuits connected to field wiring terminals, shall be isolated from mains – Class III (SELV/PELV)

Indication LEDs located above the connector:

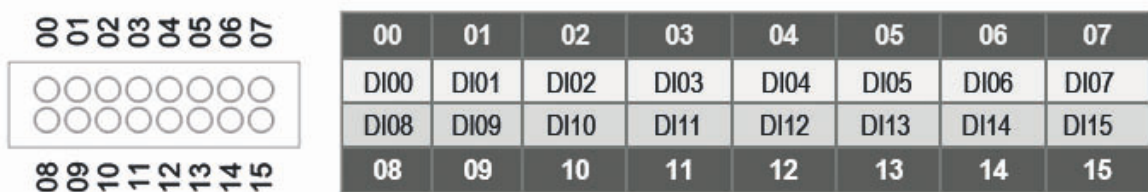

Fig 15. Module indication LEDs.

2.6.1.2 4 Digital Input 2 Fast Digital Input

Digital input module with 4 digital x 24Vdc inputs and 2 fast digital x 24Vdc inputs.

Main characteristics:

Digital Inputs	
Functional	
Number of inputs	4 isolated (DI00..DI03)
Input type and ranges	
Input current	2mA (min.), 4mA (max.)
Input delay time	1ms (max.)
Count speed	200 count/s
Count range	32 bits
Electrical	
Nominal voltage	24VDC
Input inactive range	0V to 11V
Input active range	16,8V to 30V

Tbl 34. Digital Inputs. Technical Data.

Fast Digital Inputs	
Functional	
Number of inputs	2 isolated (DI04..DI05)
Input type and ranges	
Input current	6mA (min.), 14mA (max.)
Input delay time	1µs (max.)
Count speed	50.000 count/s
Count range	32 bits
Electrical	
Nominal voltage	24VDC
Input inactive range	0V to 4V
Input active range	16,8V to 30V

Tbl 35. Fast Digital Input. Technical Data.

Additional Features Digital Inputs	
8 leds for user use	
Period measurement of one of the six digital input signals	
Pulse counter for A or AB encoder. Any of the six digital input signals could be used as A or B signal	

Tbl 36. Additional Features.

Connector and pinout is as follows:

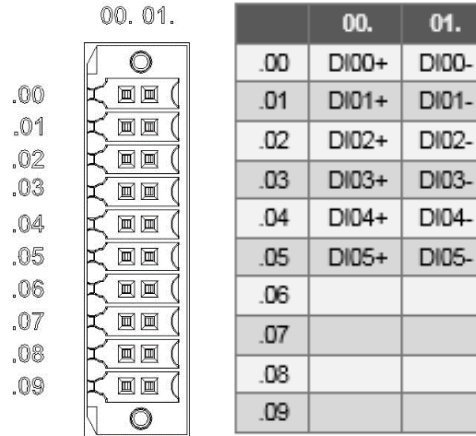

Fig 16. Module connector and pinout.

Signals:

DI00-DI03: Digital Inputs.

DI04-DI05: Fast Digital Inputs.

Note:

External circuits connected to field wiring terminals, shall be isolated from mains – Class III (SELV/PELV)

Indication LEDs located above the connector:



Fig 17. Module indication LEDs.

00 - 03: Leds of digital inputs.

04 - 05: Leds of fast digital inputs.

08 - 15: User-managed leds.

↑, ↓: Represent up or down counts related with AB encoder functionality.
If only channel A encoder is used, the count up led will be on.

2.6.1.3 16 NPN Digital Input

Digital input module with 16 x 24Vdc inputs with common reference.

Main characteristics:

Digital Inputs	
Functional	
Number of inputs	16
Connection mode	One common return
Input polarity	Negative (type NPN)
Input delay time	0.5ms (max.)

Digital Inputs	
Functional	
Electrical	
Input to system isolation	2500Vdc, 60s
Isolation between inputs	No
Nominal voltage	24Vdc
Low level	0V to 11V
High level	16,8V to 30V
Input current	3mA (typ.) @ 24V

Tbl 37. Digital Inputs. Technical Data.

Connector and pinout is as follows:

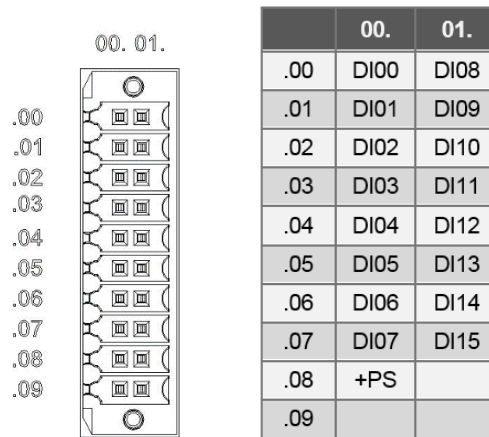

Fig 18. Digital Input connector and pinout.

Note:

External circuits connected to field wiring terminals, shall be isolated from mains – Class III (SELV/PELV)

Indication LEDs located above the connector:

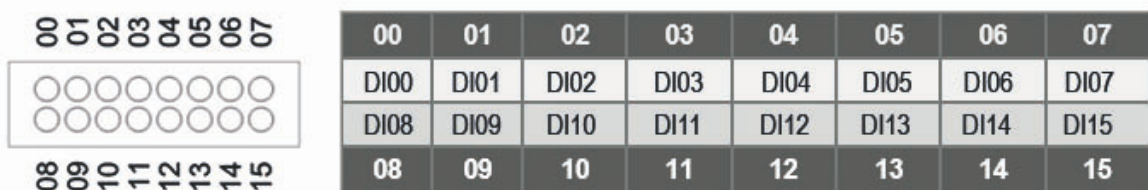

Fig 19. Module indication LEDs.

2.6.1.4 16 Digital Output

Digital output module with 16 x 24Vdc outputs with common reference.

Main characteristics:

Digital Outputs	
Functional	
Number of outputs	16
Connection mode	Common high side drive (type PNP)
Output delay time	0.5ms (max.) (resistive load)
Operating rate	1Khz (max.) (resistive load)
Electrical	
Output technology	Solid state relay (SSR)
Isolation output to system	2500Vdc, 60s
Isolation between outputs	No
Aux. supply voltage	24Vdc (rated) 16,8Vdc (min.), 30Vdc (max.)
Max. Aux. supply current	Sum of all output currents plus 15mA 4A on PSa + 4A on PSb
Max. current per output	500mA DC Pilot Duty
Max. inductive load	7H on unique output commutation basis 1.1H on 8 outputs simultaneous commutation basis UL tested at 282mH
Max. short circuit current per output	1.7A, limited by SSR protection

Tbl 38. Digital Outputs. Technical Data.

Note:

+PSa is supply for DO0, DO1, DO2, DO3, DO8, DO9, DO10, DO11

+PSb is supply for DO4, DO5, DO6, DO7, DO12, DO13, DO14, DO15

Connector and pinout is as follows:

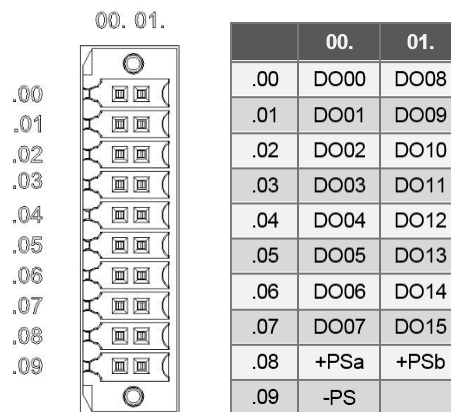

Fig 20. Digital Output connector and pinout.

Note:

External circuits connected to field wiring terminals, shall be isolated from mains – Class III (SELV/PELV)

Indication LEDs located above the connector:

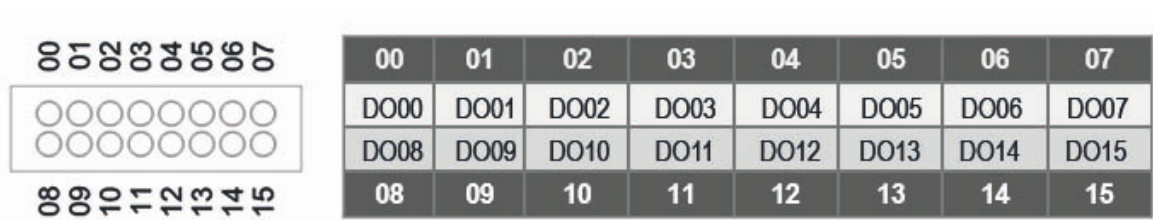

Fig 21. Module indication LEDs.

2.6.1.5 8 2A Digital Output

Digital outputs module with 8 x 24Vdc outputs with common reference.

Main characteristics:

Digital Outputs	
Functional	
Number of outputs	8
Connection mode	High side drive with particular power to each signal and negative common to all
Output delay time	0.5ms (max.) (resistive load)
Electrical	
Output technology	MOSFET
Isolation output to system	2500Vdc
Isolation between outputs	No
Aux. supply voltage	24Vdc (rated) 16,8Vdc (min.), 30Vdc (max.)
Aux. supply current	Sum of all output currents plus 50mA
Max. current per output	2A
Short circuit current limitation	Yes
Maximum leakage current of inactive output	10µA @ 24Vdc
Maximum internal resistance of the activated output	0,2ohm
Maximum inductive load allowed in individual output	0,1H to 2A of current
Isolation. Test voltage	
Between TSX bus and ground	500Vdc
Between the signal connector and ground	2000Vdc
Between the TSX bus and the signal connector	2500Vdc

Tbl 39. Digital Outputs. Technical Data.

Connector and pinout is as follows:

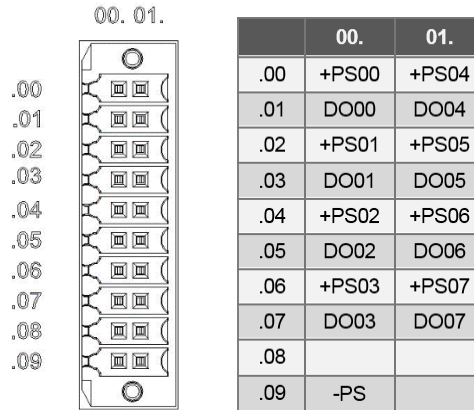

Fig 22. Digital Outputs connector and pinout.

Note:

External circuits connected to field wiring terminals, shall be isolated from mains – Class III (SELV/PELV)

Indication LEDs located above the connector:

00	01	02	03	04	05	06	07
DO0	DO1	DO2	DO3	DO4	DO5	DO6	DO7
ON	ON	ON	ON	ON	ON	ON	ON
OK	OK	OK	OK	OK	OK	OK	OK
08	09	10	11	12	13	14	15

Fig 23. Module indication LEDs.

The DOxx ON signaling light up (red) to indicate that the corresponding output has the activation command registered.

The DOxx OK signaling light up (green) to indicate that there is power in the corresponding output and the module status is OK. Diagnosis indications are activated once the processor unit is accessing this module (CPU is ON RUN status and I/O transactions are active)

2.6.1.6 16 NPN Digital Output

Digital output module with 16 x 24Vdc outputs with common reference.

Main characteristics:

Digital Outputs	
Functional	
Number of outputs	16
Connection mode	Common low side drive (type NPN)
Output delay time	0.5ms (max.) (resistive load)
Operating rate	1Khz (max.) (resistive load)
Electrical	
Output technology	Solid state relay (SSR)
Working voltage	24Vdc (rated), 30Vdc (max.)
Isolation output to system	2500Vdc, 60s
Isolation between outputs	No
Max. current per output	250mA

Digital Outputs	
Functional	
Max. short circuit current per output	900mA, limited by SSR protection

Tbl 40. Digital Outputs. Technical Data.

Connector and pinout is as follows:

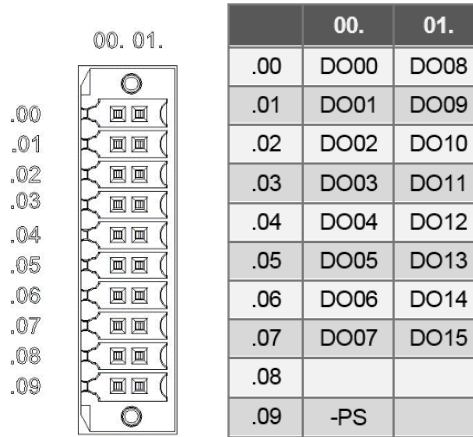

Fig 24. Digital Output connector and pinout.

Note:

External circuits connected to field wiring terminals, shall be isolated from mains – Class III (SELV/PELV)

Indication LEDs located above the connector:

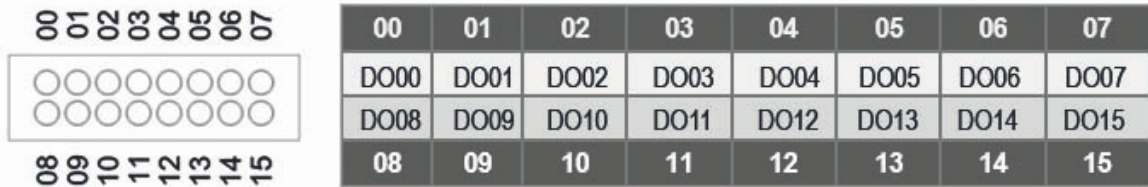

Fig 25. Module indication LEDs.

2.6.1.7 8 Digital Input 8 Digital Output

Digital inputs / outputs module with 8 x 24Vdc inputs with common reference and 8 x 24Vdc outputs with common reference.

Main characteristics:

Digital Inputs	
Functional	
Number of inputs	8
Connection mode	One common return
Input polarity	Positive
Input delay time	0.5ms (max.)
Electrical	
Input to system isolation	2500Vdc, 60s
Isolation between inputs	No

Digital Inputs	
Functional	
Nominal voltage	24Vdc
Low level	0V to 11V
High level	16,8V to 30V
Input current	3mA (typ.) @ 24V

Tbl 41. Digital Inputs. Technical Data.

Digital Outputs	
Functional	
Number of outputs	8
Connection mode	Common high side drive
Output delay time	0.5ms (max.) (resistive load)
Operating rate	1Khz (max.) (resistive load)
Electrical	
Output technology	Solid state relay (SSR)
Isolation output to system	2500Vdc, 60s
Isolation between outputs	No
Aux. supply voltage	24Vdc (rated) 16,8Vdc (min.), 30Vdc (max.)
Max. Aux. supply current	Sum of all output currents plus 15mA 4A on PS+
Max. current per output	500mA DC Pilot Duty
Max. inductive load	7H on unique output commutation basis 1.1H on 8 outputs simultaneous commutation basis UL tested at 282mH
Max. short circuit current per output	1.7A, limited by SSR protection

Tbl 42. Digital Outputs. Technical Data.

Connector and pinout is as follows:

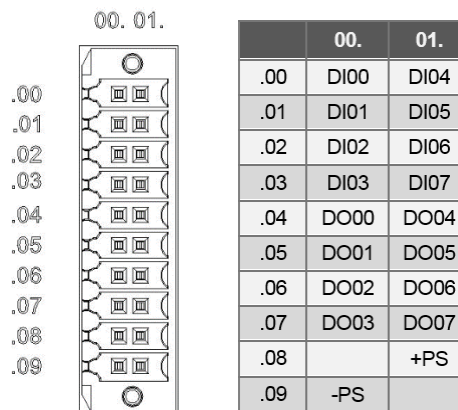

Fig 26. Digital Inputs / Outputs connector and pinout.

Note:

External circuits connected to field wiring terminals, shall be isolated from mains – Class III (SELV/PELV)

Indication LEDs located above the connector:

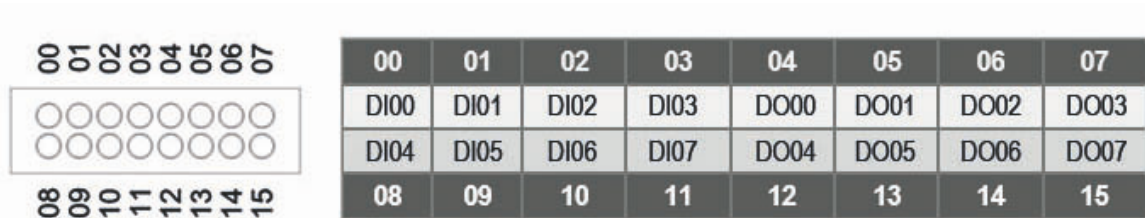

Fig 27. Module indication LEDs.

2.6.1.8 12 Digital Input 4 Digital Output

Digital inputs / outputs module with 12 x 24Vdc inputs with common reference and 4 x 24Vdc outputs with common reference.

Main characteristics:

Digital Inputs	
Functional	
Number of inputs	12
Connection mode	One common return
Input polarity	Positive
Input delay time	0.5ms (max.)
Electrical	
Input to system isolation	2500Vdc, 60s
Isolation between inputs	No
Nominal voltage	24Vdc
Low level	0V to 11V
High level	16,8V to 30V
Input current	3mA (typ.) @ 24V

Tbl 43. Digital Inputs. Technical Data.

Digital Outputs	
Functional	
Number of outputs	4
Connection mode	Common high side drive
Output delay time	0.5ms (max.) (resistive load)
Operating rate	1Khz (max.) (resistive load)
Electrical	
Output technology	Solid state relay (SSR)
Isolation output to system	2500Vdc, 60s

Digital Outputs	
Functional	
Isolation between outputs	No
Aux. supply voltage	24Vdc (rated) 16,8Vdc (min.), 30Vdc (max.)
Max. Aux. supply current	Sum of all output currents plus 15mA 2A on PS+
Max. current per output	500mA DC Pilot Duty
Max. inductive load	7H on unique output commutation basis 1.1H on 8 outputs simultaneous commutation basis UL tested at 282mH<
Max. short circuit current per output	1.7A, limited by SSR protection

Tbl 44. Digital Outputs. Technical Data.

Connector and pinout is as follows:

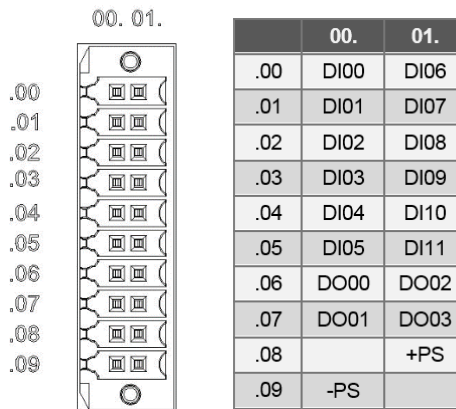

Fig 28. Digital Inputs / Outputs connector and pinout.

Note:

External circuits connected to field wiring terminals, shall be isolated from mains – Class III (SELV/PELV)

Indication LEDs located above the connector:

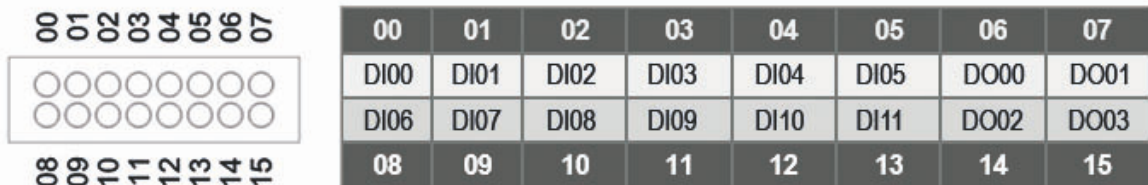

Fig 29. Module indication LEDs.

2.6.1.9 4 Digital Input 12 Digital Output

Digital inputs / outputs module with 4 x 24Vdc inputs with common reference and 12 x 24Vdc outputs with common reference.

Main characteristics:

Digital Inputs	
Functional	
Number of inputs	4
Connection mode	One common return
Input polarity	Positive
Input delay time	0.5ms (max.)
Electrical	
Input to system isolation	2500Vdc, 60s
Isolation between inputs	No
Nominal voltage	24Vdc
Low level	0V to 11V
High level	16,8V to 30V
Input current	3mA (typ.) @ 24V

Tbl 45. Digital Inputs. Technical Data.

Digital Outputs	
Functional	
Number of outputs	12
Connection mode	Common high side drive
Output delay time	0.5ms (max.) (resistive load)
Operating rate	1Khz (max.) (resistive load)
Electrical	
Output technology	Solid state relay (SSR)
Isolation output to system	2500Vdc, 60s
Isolation between outputs	No
Aux. supply voltage	24Vdc (rated) 16,8Vdc (min.), 30Vdc (max.)
Max. Aux. supply current	Sum of all output currents plus 15mA 2A on PSa + 4A on PSb
Max. current per output	500mA DC Pilot Duty
Max. inductive load	7H on unique output commutation basis 1.1H on 8 outputs simultaneous commutation basis UL tested at 282mH
Max. short circuit current per output	1.7A, limited by SSR protection

Tbl 46. Digital Outputs. Technical Data.

Note:

+PSa is supply for DO0, DO1, DO6, DO7

+PSb is supply for DO2, DO3, DO4, DO5, DO8, DO9, DO10, DO11

Note:

External circuits connected to field wiring terminals, shall be isolated from mains – Class III (SELV/PELV)

Connector and pinout is as follows:

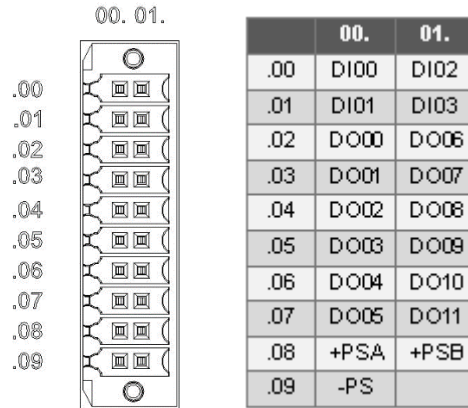

Fig 30. Digital Inputs / Outputs connector and pinout.

Indication LEDs located above the connector:

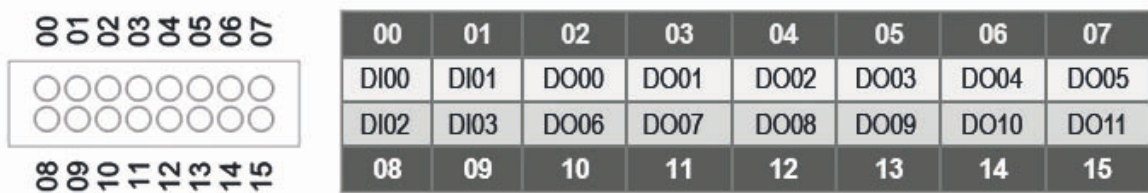

Fig 31. Module indication LEDs.

2.6.1.10 3 Relay Output

Relay output module with 3 electromechanical relay up to 5A per output.

Main characteristics:

Digital Outputs Relay	
Functional	
Number of outputs	3
Connection mode	3 points switching contact (NO/NC)
Electrical	
Output technology	Electromechanical relay
Isolation output to system	2500Vdc, 60s
Isolation between outputs	Functional
Aux. supply voltage	24Vdc (rated) 16,8Vdc (min.), 30Vdc (max.)
Aux. supply current	100mA (max.)
Max. current per output	5A @ 20°C, 2A @ 70°C
Max. contact voltage	160Vdc

Tbl 47. Digital Outputs Relay. Technical Data.

Connector and pinout is as follows:

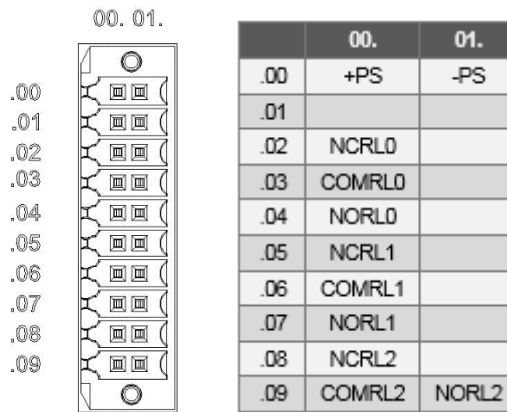

Fig 32. Digital Output Relay connector and pinout.

Note:

External circuits connected to field wiring terminals, shall be isolated from mains – Class III (SELV/PELV)

Indication LEDs located above the connector:

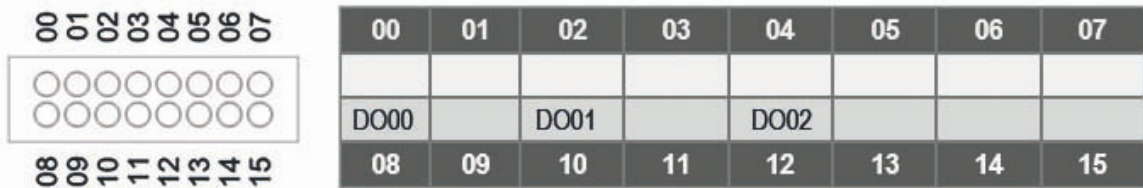

Fig 33. Module indication LEDs.

2.6.2 Analog Modules

2.6.2.1 8 Analog Input

Analog input module with 8 V/I analog inputs.

Main characteristics:

Analog Inputs	
Functional	
Number of inputs	8
Connection mode	Common GND reference
Input signal	Voltage / Current
Measurement ranges	+/- 10V, +/- 5V, +/- 1V, 0 to 10V, 0 to 5V +/- 20mA, 0 to 20mA, + 4mA to 20mA
Refresh time	0,56ms
A/D converter	13 bits
Electrical	
Break down current in current mode	+/- 35mA
Break down voltage	+/- 15V
Isolation input to system	1500Vac, 60s

Analog Inputs	
Functional	
Isolation between inputs	No
Input impedance, voltage mode	>33Kohm
Input impedance, current mode	440ohm (min.), 460ohm (max.)

Tbl 48. Analog Inputs. Technical Data.

Connector and pinout is as follows:

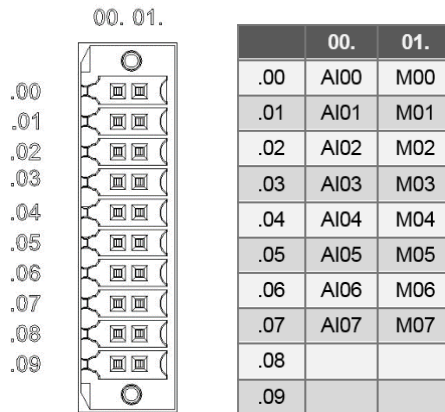

Fig 34. Analog Input connector and pinout.

Note:

There are no signaling elements.

External circuits connected to field wiring terminals, shall be isolated from mains – Class III (SELV/PELV)

2.6.2.2 4IEPE 4 Fast Analog Input

Analog input module with 4 IEPE accelerometer input signals and 4 high speed V/I analog inputs with common reference. Main characteristics:

IEPE Inputs	
Functional	
Number of inputs	4
IEPE sensor	+/-5V , +/-1V
Input connection	Single ended
Sampling rate	Up to 100Ks/sec
Input resolution	Up to16bits
Electrical	
Isolation	
Front connector to system connector	1500Vdc 1min
Front connector to earth	1500Vdc 1min
Max Input voltage	+/- 15V from any AI(+/-) input to M point
Input Impedance	
Voltage mode	>500Kohm
Current mode	440ohm (typ.)

IEPE Inputs	
Functional	
Aux. supply voltage	24Vdc +/- 10%
Aux. supply current	130mA (max.) / 80mA (typ.) @ 24Vdc

Tbl 49. IEPE Inputs. Technical Data.

Analog Inputs	
Functional	
Number of inputs	4
Connection mode	Common GND reference
Input signal	Voltage / Current
Measurement ranges	+/- 10V, +/- 5V, +/- 1V, 0 to 10V, 0 to 5V +/- 20mA, 0 to 20mA, + 4mA to 20mA
Sampling rate	Up to 100Ks/sec
A/D converter	16 bits
Electrical	
Break down current in current mode	+/- 35mA
Break down voltage	+/- 15V
Isolation input to system	1500Vac, 60s
Isolation between inputs	No
Input impedance, voltage mode	>500Kohm
Input impedance, current mode	440ohm (min.), 460ohm (max.)

Tbl 50. Analog Inputs. Technical Data.

Connector and pinout is as follows:

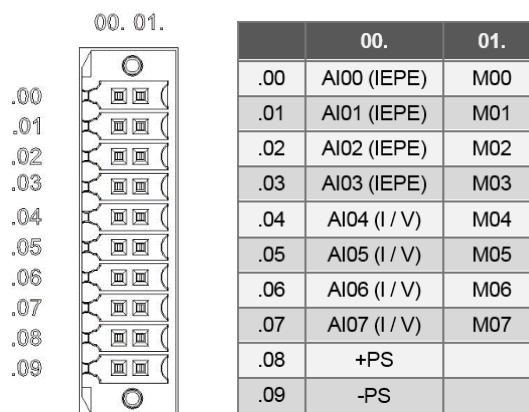

Fig 35. Module connector and pinout.

Note:
There are no signaling elements.

External circuits connected to field wiring terminals, shall be isolated from mains – Class III (SELV/PELV)

2.6.2.3 6IEPE 2 Fast Analog Input

Analog input module with 6 IEPE accelerometer input signals and 2 high speed V/I analog inputs with common reference.

Main characteristics:

IEPE Inputs	
Functional	
Number of inputs	6
IEPE sensor	+/-5V , +/-1V
Input connection	Single ended
Sampling rate	Up to 100Ks/sec
Input resolution	Up to 16bits
Electrical	
Max Input voltage	+/- 15V from any AI _n (+/-) input to M point
Isolation	
Front connector to system connector	1500Vdc 1min
Front connector to earth	1500Vdc 1min
Input Impedance	
Voltage mode	>500Kohm
Current mode	440ohm (typ.)

Tbl 51. IEPE Inputs. Technical Data.

Analog Inputs	
Functional	
Number of inputs	2
Connection mode	Common GND reference
Input signal	Voltage / Current
Measurement ranges	+/- 10V, +/- 5V, +/- 1V, 0 to 10V, 0 to 5V +/- 20mA, 0 to 20mA, + 4mA to 20mA
Sampling rate	Up to 100Ks/sec
A/D converter	16 bits
Electrical	
Break down current in current mode	+/- 35mA
Break down voltage	+/- 15V
Isolation input to system	1500Vac, 60s
Isolation between inputs	No
Input impedance, voltage mode	>500Kohm
Input impedance, current mode	440ohm (min.), 460ohm (max.)

Tbl 52. Analog Inputs. Technical Data.

Auxiliary Power Supply	
Electrical	
Aux. supply voltage	24Vdc +/- 10%
Aux. supply current	130mA (max.) / 80mA (typ.) @ 24Vdc

Tbl 53. Auxiliary Power Supply. Technical Data.

Connector and pinout is as follows:

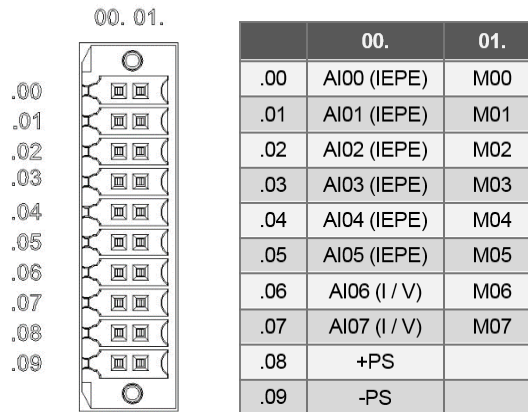

Fig 36. Module connector and pinout.

Note:

There are no signaling elements.

External circuits connected to field wiring terminals, shall be isolated from mains – Class III (SELV/PELV)

2.6.2.4 10 Temperature Input

Module for the acquisition of temperature signals from different temperature sensor types (PT100 2/3wires, NTC, Thermocouple).

Main characteristics:

Temperature Inputs	
Functional	
Number of inputs	Up to 10 temperature inputs depending on the sensor type and connection
Connection mode	2 wires, 3 wires
Input signal	PT100 sensor (2-3wires), NTC, TC
Measurement ranges	
NTC	4.7 .. 470 Kohm
PT100	-50 .. +200 °C
TermoCouple J	-40 .. +750 °C
TermoCouple K	-200 ..+1350 °C
TermoCouple T	-200 .. +350 °C
Refresh time	2s (max.)
A/D converter	16bits

Temperature Inputs	
Functional	
Electrical	
Open circuit voltage	3,4V (max.)
PT100 current	1,6mA (max.)
Isolation input to system	1500Vac, 60s
Isolation between inputs	No

Tbl 54. Temperature module. Technical Data.

Connector and pinout is as follows:

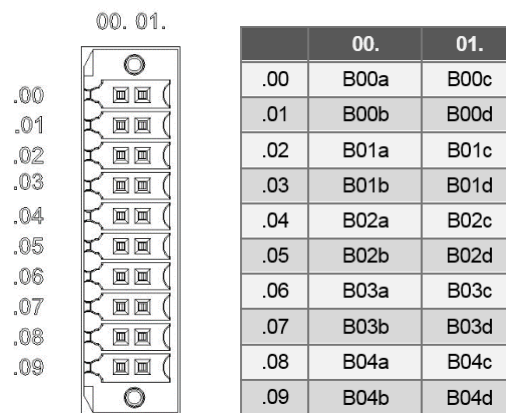

Fig 37. Temperature module connector and pinout.

Note:

External circuits connected to field wiring terminals, shall be isolated from mains – Class III (SELV/PELV)

Internally the module is divided in 5 signal blocks (each block has 4 terminals). Each block contains two possible input channels (TX-TY):

- B0 → T0-T1
- B1 → T2-T3
- B2 → T4-T5
- B3 → T6-T7
- B4 → T8-T9

In following figures, the connection diagram for the different types of sensors is represented:

a) NTC + NTC / PT100 + PT100.

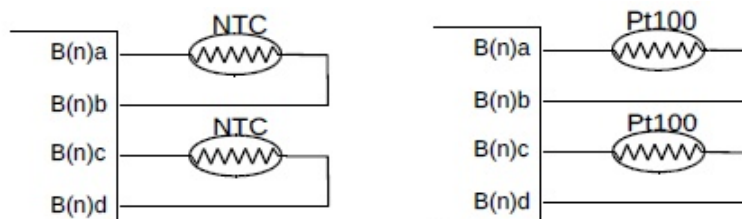

Fig 38. NTC + NTC // PT100 + PT100 (2-wires) connection diagram.

b) NTC + PT100 (2-wires) / PT100 (2-wires) + NTC. Both sensors share a common electrical point

formed by B(n)b y B(n)d.

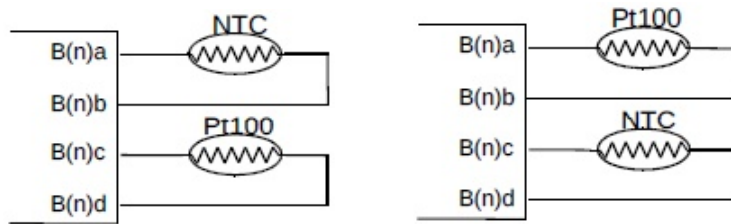

Fig 39. NTC + PT100 (2-wires) // PT100 (2-wires) + NTC connection diagram.

c) NTC + Empty sensor / PT100 (2-wires) + Empty

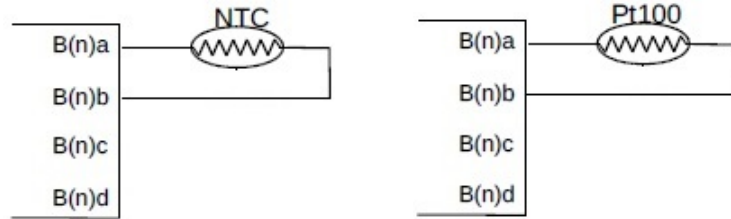

Fig 40. NTC + Empty // PT100 + Empty connection diagram.

d) PT100 (3-wires) or Differential thermocouple

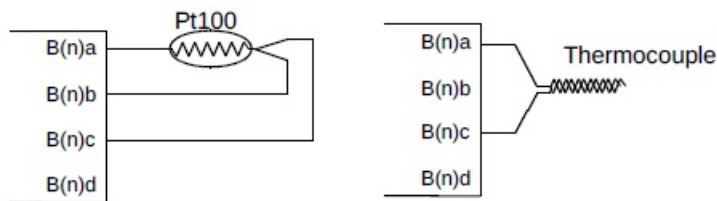

Fig 41. Pt100 (3-wire) // ThermoCouple connection diagram.

Note:

In all cases both sensors share a common electrical point formed by B(n)b y B(n)d. There are no signaling elements.

2.6.2.5 4 Analog Output

Analog output module with 4 V/I analog outputs with common reference, 16 bit converter.

Main characteristics:

Analog Outputs	
Functional	
Number of outputs	4
Connection mode	Common GND reference
Output signal	Voltage / Current
Output ranges	+/- 10V, +/- 5V, +/- 1V, 0 to 10V, 0 to 5V +/- 20mA, 0 to 20mA, + 4mA to 20mA
Refresh time	0,6ms
D/A converter bits	16
Electrical	
Aux. supply voltage	24Vdc, +25% -30%

Analog Outputs	
Functional	
Aux. supply current	150mA (max.) , with all outputs at 20mA
Isolation output to system	1500Vac, 60s
Isolation between outputs	No
Resistive load in voltage mode	1Kohm (min.)
Resistive load in current mode	500ohm (max.)

Tbl 55. Analog Outputs. Technical Data.

Connector and pinout is as follows:

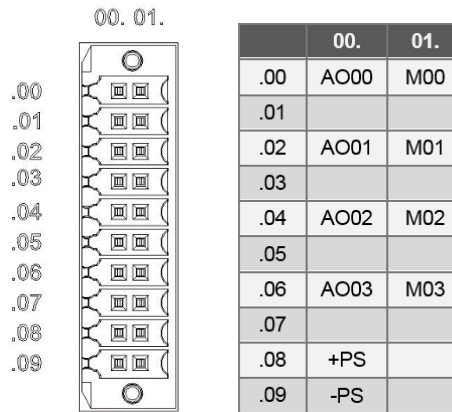

Fig 42. Analog Output connector and pinout.

Note:

There are no signaling elements.

External circuits connected to field wiring terminals, shall be isolated from mains – Class III (SELV/PELV)

2.6.3 Specific Function Modules

2.6.3.1 DC Motor Control module

This module is oriented to control DC motors, including one PWM digital output with H bridge function, additionally one 24bit encoder input and 4 digital inputs for DC drives control.

2.6.3.1.1 DC Motor Control

Main characteristics:

Digital Inputs	
Functional	
Number of inputs	4 isolated
Input type and ranges	
Voltage	24VDC
Input current	2mA (min.), 4mA (max.)
Input delay time	1ms (max.)
Electrical	
Nominal voltage	24VDC

Digital Inputs	
Functional	
Input inactive range	0V to 11V
Input active range	16,8V to 30V

Tbl 56. Digital Inputs. Technical Data.

Encoder Input	
Functional	
Encoders supported	Incremental Encoder A, B signals
Count speed	50.000 count/sec
Count range	24 bits
Electrical	
Voltage	24VDC
Counter signals standard	HTL or PNP/NPN @24VDC

Tbl 57. Encoder Input. Technical Data.

Motor Output	
Functional	
Output type	PWM H Bridge
Short circuit protection	Yes
Output current measurement	Yes
Electrical	
Supply voltage	24VDC + 25%, -30%
Max. motor current	5A continuous, 6A peak
Idle supply current	40mA (typ.) 60mA (max.)

Tbl 58. Motor Output. Technical Data.

Connector and pinout is as follows:

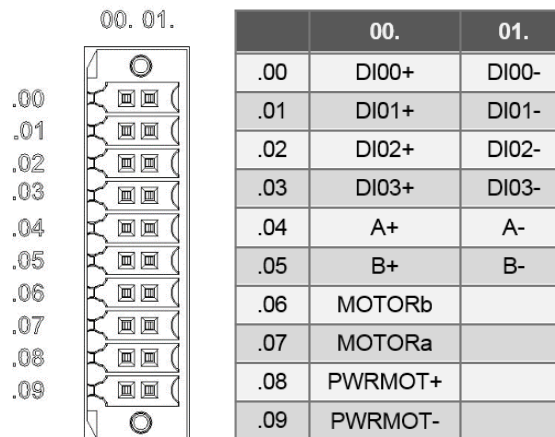

Fig 43. Motor module connector and pinout.

Signals:

DI00-DI03:
A+/A-, B+/B-:

Digital Inputs
Encoder Inputs

MOTORa, MOTORb: Output to Motor
 PWRMOT+, PWRMOT- Power Supply

Note:

External circuits connected to field wiring terminals, shall be isolated from mains – Class III (SELV/PELV)

Indication LEDs located above the connector:

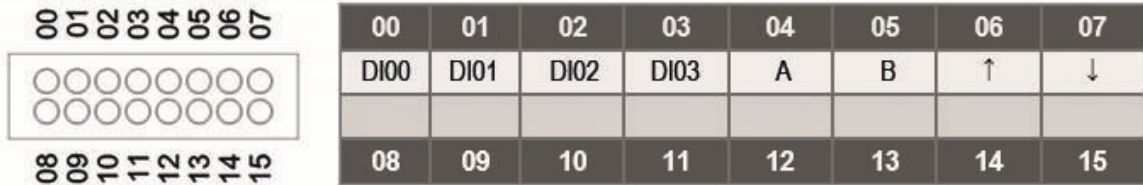

Fig 44. Module indication LEDs.

2.6.3.1.2 High Power DC Motor Control

Main characteristics:

Digital Inputs	
Functional	
Number of inputs	4 isolated
Input type and ranges	
Input current	2mA (min.), 4mA (max.)
Input delay time	1ms (max.)
Electrical	
Nominal voltage	24VDC
Input inactive range	0V to 11V
Input active range	16,8V to 30V

Tbl 59. Digital Inputs. Technical Data.

Encoder Input	
Functional	
Encoders supported	Incremental Encoder A, B signals
Count speed	50.000 count/sec
Count range	24 bits
Electrical	
Voltage	24VDC
Counter signals standard	HTL or PNP/NPN @24VDC

Tbl 60. Encoder Input. Technical Data.

Motor Output	
Functional	
Output type	PWM H Bridge

Motor Output	
Functional	
Short circuit protection	Yes
Output current measurement	Yes
Electrical	
Supply voltage	24VDC + 25%, -30%
Max. motor current	12A
Idle supply current	40mA (typ.) 60mA (max.)

Tbl 61. Motor Output. Technical Data.

Connector and pinout is as follows:

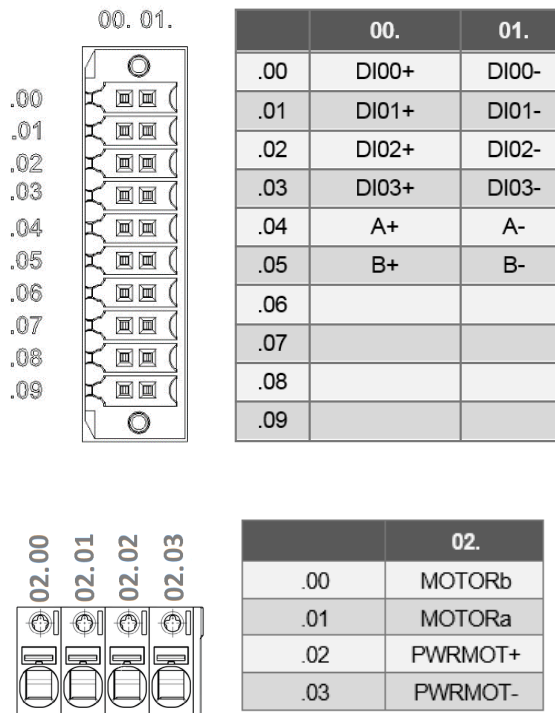

Fig 45. Motor module connector and pinout.

Signals:

- | | |
|-------------------|-----------------|
| DI00-DI03: | Digital Inputs |
| A+/A-, B+/B-: | Encoder Inputs |
| MOTORa, MOTORb: | Output to Motor |
| PWRMOT+, PWRMOT-: | Power Supply |

Note:

External circuits connected to field wiring terminals, shall be isolated from mains – Class III (SELV/PELV)

Indication LEDs located above the connector:

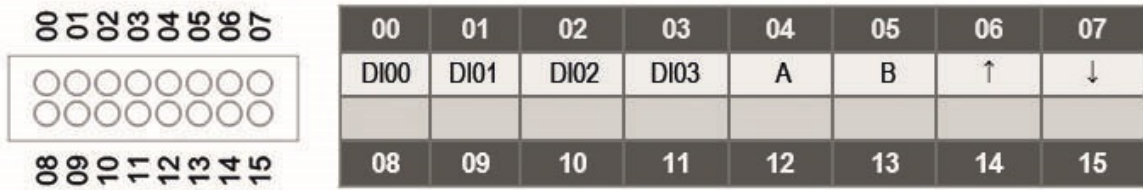

Fig 46. Module indication LEDs.

2.6.3.2 Audio Output module

This module incorporates two audio channels and can play up to 1 min duration messages.

Main characteristics:

Audio Outputs	
Functional	
Number of outputs	1 (With two amplifiers)
Connection mode	20-point socket for overhead connector
Electrical	
Aux. supply voltage	24VDC +25%, -30%
Aux. supply current	1A (max.)
Output power cont.	2W (max.) RMS

Tbl 62. Audio Outputs. Technical Data.

Connector and pinout is as follows:

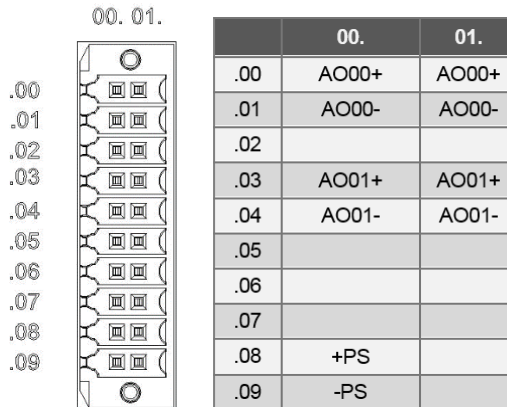

Fig 47. Audio module connector and pinout.

Note:

There are no signaling elements.

External circuits connected to field wiring terminals, shall be isolated from mains – Class III (SELV/PELV)

2.6.3.3 Condition Monitoring

2.6.3.3.1 Basic

Main characteristics:

Analog Inputs	
Functional	
Number of inputs	1
Connection mode	Common GND reference
Input signal	Current
Measurement ranges	+/- 20mA, 0 to 20mA, + 4mA to 20mA
Refresh time	0,56ms
Input resolution	16bits
Error full scale at 25°	+/- 0,1%
Electrical	
Break down current in current mode	+/- 35mA
Break down voltage	+/- 15V
Isolation input to system	1500Vac, 60s
Isolation between inputs	No
Input impedance, voltage mode	>33Kohm
Input impedance, current mode	440ohm (min.), 460ohm (max.)

Tbl 63. Analog Inputs. Technical Data.

IEPE Inputs	
Functional	
Number of inputs	4
Signal input range	+/- 5V
Input connection	Single ended
Sampling rate	48Ks/sec
Dynamic range	96dB
Useful band	0.1Hz to 20kHz
Input resolution	18bits
Error full scale at 25°	+/- 0,1%
Diagnostic	
Number	1 measurement per IEPE input
Diagnostic Type	Bias Output Voltage measurement (0 to 24V)
Input resolution	16bits
Error full scale at 25°	+/- 1%
Electrical	
Isolation	
Front connector to system	1500Vdc 1min
Front connector to earth	1500Vdc 1min

Tbl 64. IEPE Inputs. Technical Data.

Encoder Input	
Functional	
Input supported	Incremental Encoder (A, B signals) or 3 individual Digital Inputs for speed measurement
Count speed	50.000count/sec
Input resolution	32bits
Error full scale at 25°	+/- 0,01%
Electrical	
Counter signals standard	HTL or PNP/NPN @24Vdc

Tbl 65. Encoder Input. Technical Data.

Auxiliary Power Supply	
Electrical	
Aux. supply voltage	24Vdc +/- 10%
Aux. supply current	130mA (max.) / 80mA (typ.) @ 24Vdc

Tbl 66. Auxiliary Power Supply. Technical Data.

Connector and pinout is as follows:

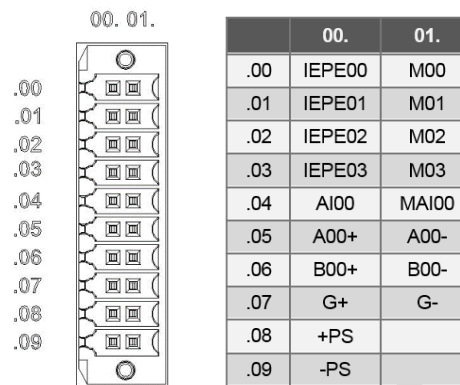

Fig 48. Module connector and pinout.

Signals:

- AI00: Analog Input
- IEPE00..IEPE03: IEPE Inputs
- A00+, A00-: Encoder Inputs
- B00+, B00-: Encoder Inputs
- G+, G-: Encoder Inputs
- +PS, -PS: Power Supply

Note:

External circuits connected to field wiring terminals, shall be isolated from mains – Class III (SELV/PELV)

Indication LEDs located above the connector:

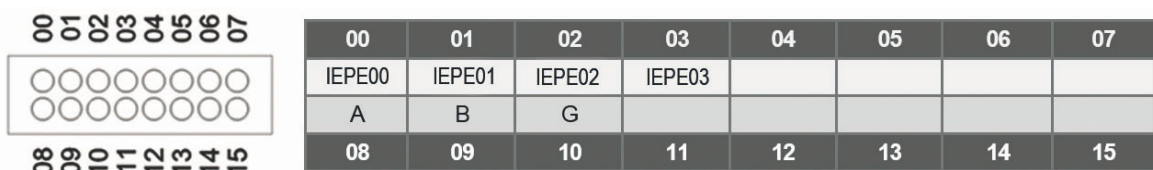

Fig 49. Module indication LEDs.

LED	LIT	OFF
IEPE00 .. IEPE03	IEPE input signal correct level (red)	Not configured or IEPE input signal incorrect level

Tbl 67.2AI 4IEPE 1ENC status LEDs.

2.6.3.3.2 Advanced

Main characteristics:

IEPE Inputs	
Functional	
Number of inputs	8
IEPE sensor	+/-5V , +/-1V
Input connection	Single ended
Sampling rate	Up to 100Ks/sec
Input resolution	Up to 24bits
Electrical	
Input Impedance	>500Kohm
Isolation	
Front connector to system connector	1500Vdc 1min
Front connector to earth	1500Vdc 1min

Tbl 68. IEPE Inputs. Technical Data.

Digital Inputs	
Functional	
Number of inputs	6
Connection mode	Differential
Type	HTL, NPN, PNP (24Vdc) or Encoder Input (in groups of 2)
Max.Input Frequency	100Kpulses/s
Counter resolution	24bits
Electrical	
Input to system isolation	2500Vdc, 60s
Isolation between inputs	No
Nominal voltage	24Vdc
Low level	0V to 11V
High level	16,8V to 30V
Input current	3mA (typ.) @ 24V

Tbl 69. Digital Inputs. Technical Data.

Digital Outputs	
Functional	
Number of outputs	2
Connection mode	Common high side drive (type PNP)

Digital Outputs	
Functional	
Output delay time	0.5ms (max.) (resistive load)
Operating rate	1Khz (max.) (resistive load)
Electrical	
Output technology	Solid state relay (SSR)
Isolation output to system	2500Vdc, 60s
Isolation between outputs	No
Aux. supply voltage	24Vdc (rated) 16,8Vdc (min.), 30Vdc (max.)
Max. Aux. supply current	600mA
Max. current per output	200mA DC Pilot Duty
Max. inductive load	1.1H on unique output commutation basis UL tested at 282mH
Max. short circuit current per output	1.7A, limited by SSR protection

Tbl 70. Digital Outputs. Technical Data.

Analog Inputs	
Functional	
Number of inputs	4
Connection mode	2 wires, 3 wires
Input signal	PT100 sensor (2-3wires), NTC or ThermoCouple or AI (+-10V / +-20mA)
Measurement ranges	
NTC	4.7 .. 470 Kohm
PT100	-50 .. +200 °C
ThermoCouple J	-40 .. +750 °C
ThermoCouple K	-200 .. +1350 °C
ThermoCouple T	-200 .. +350 °C
Refresh time ¹	AI inputs: 10ms (max.) Temp inputs: 200ms (max.)
Resolution	16bits
Accuracy	PT100: -50 +200 / +-2C NTC:4.7K to 470K / +-3% Thermo par: -50 to +200 / +-8C V: +-10V 1% I: +-20mA +-1%
Electrical	
Open circuit voltage	3,4V (max.)
PT100 current	1,6mA (max.)
Isolation input to system	1500Vac, 60s
Isolation between inputs	No

Tbl 71. Analog Inputs. Technical Data.

Note:

¹ Refresh time for the 4 inputs obtained by summing all inputs refresh time.

This module has 2 connectors : A and B

Connector A is as follows:

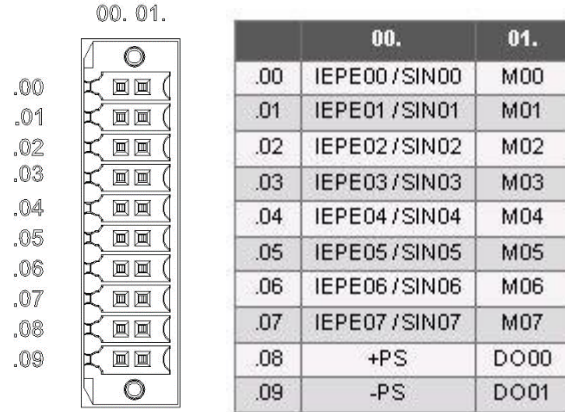

Fig 50. Module connector A .

Connector B is as follows:

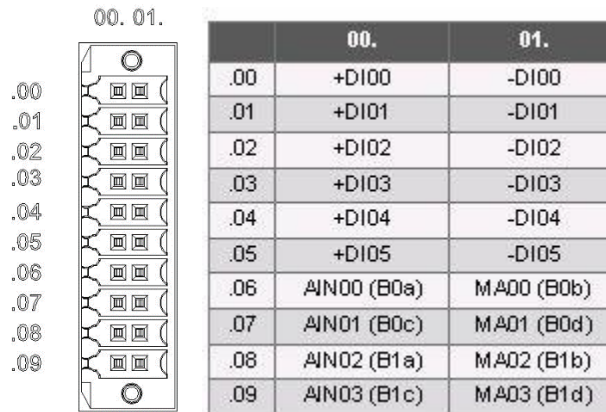

Fig 51. Module connector B.

Note:

External circuits connected to field wiring terminals, shall be isolated from mains – Class III (SELV/PELV)

Indication LEDs located above the connector:

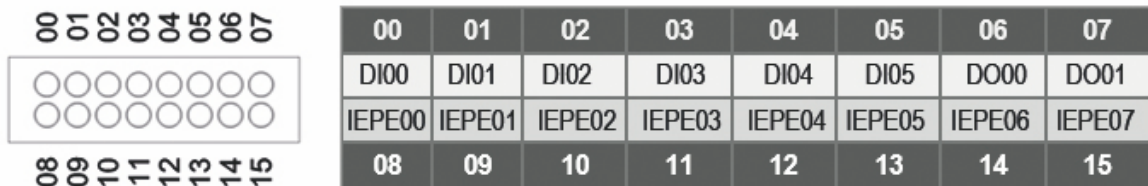

Fig 52. Module indication LEDs.



IEPE00 .. IEPE07	IEPE input signal correct level (red)	Not configured or IEPE input signal incorrect level
DI00..DI05	Input signal ON	Input signal OFF
DO00..DO01	Output signal ON	Output signal OFF

Tbl 72. Module Status LEDs.

Software Description

3 Software Description

The **INGESYS™ IC2** Controller offers powerful software tools for system programming, monitoring and diagnosis based on standards.

Main software tools are the following:

- ❑ Application development environment based on CoDeSys, software tool based on the standard IEC61131 with 5 programming languages (IL - Instruction List, ST - Structured Text, FBD - Function Block Diagram, LD - Ladder Diagram, SFC - Sequential Function Chart).

Refer to:

- "INGESYS™ IC Development Environment User Manual".
- "INGESYS™ IC IEC61131 programming manual".

- ❑ Control function library with the most standard functions for automation tasks.

Refer to:

- "Library manager on CoDeSys".

- ❑ Communication function library, specifically designed to facilitate the user the management of communication protocols.

Refer to:

- "INGESYS™ IC MODBUSTCP".
- "INGESYS™ IC CANopen solution".
- "Library manager on CoDeSys".

- ❑ Remote I/O monitoring and system management based on an embedded web server, with a panel designer tool to enable the user the design of customized data panels.

Refer to:

- "INGESYS™ IC WEB Application Manual"
- "INGESYS™ IC Panel Designer Tool Manual".

- ❑ Besides the languages defined by the IEC61131 standard, IC2-HCS-xxx system gives additionally the possibility to use MATLAB®/Simulink® (Simulink® Coder) to develop advanced regulation algorithms.

Refer to:

- "INGESYS™ IC MATLAB®/Simulink® User Manual"

Mechanical Solution

4 Mechanical Solution

4.1 System Configuration

INGESYS™ IC2 presents an internal modular and expandable design that enables its customization to application’s I/Os and communication requirements.

INGESYS™ IC2 is formed by the integration of user defined processor, communication and I/O modules, that are assembled in a compact mechanical solution. Up to 4 fieldbuses and 10 I/O modules can be selected and integrated in a compact mechanical enclosure.

In the following figure, a view of how this assembly is performed is shown:

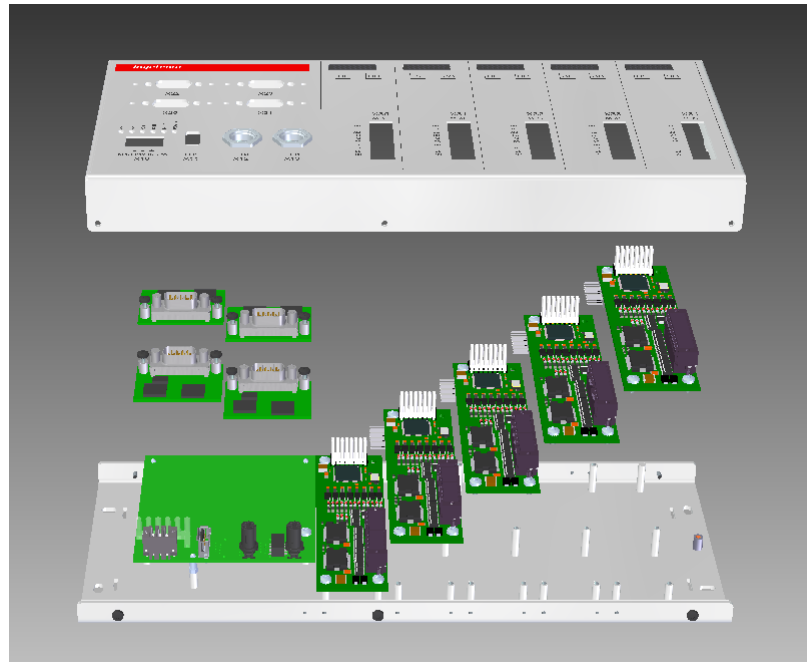

Fig 53. Mechanical solution.

Once the modules are selected, a customized mechanical enclosure to contain the whole set is designed and a unique reference code is assigned to the set. This reference is used to define precisely the new customized system for further manufacturing and commercial purposes.

In the following figure, an example of a customized final system is shown:

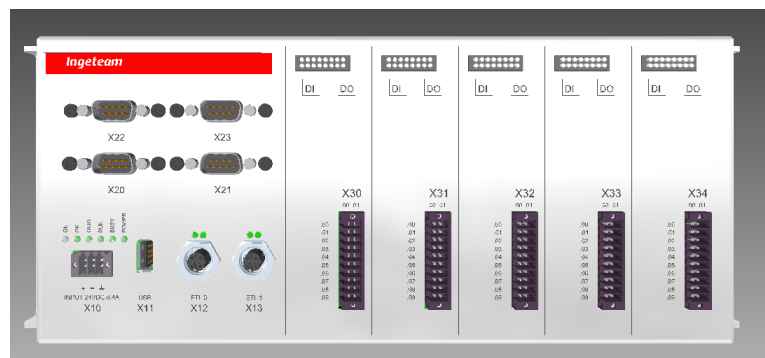

Fig 54. Customized final system.

INGESYS™ IC2 is manufactured by using pre-assembled off-the-shelf electronic modules allowing very fast delivery. All available modules have been already certified, assuring system’s quality and standards’ compliance.

4.2 Mechanical Data

The dimension of the **INGESYS™ IC2** (Controller or Remote I/O) depends on the number of I/O modules selected.

The processor or header modules are always requested and both have a width of 149mm. Each additional I/O module increase the width in 37,5mm. (Max.: 10 x I/O modules for Controller, 8 x I/O modules for Remote I/O)

The position of the fixing holes is detailed in the following figure:

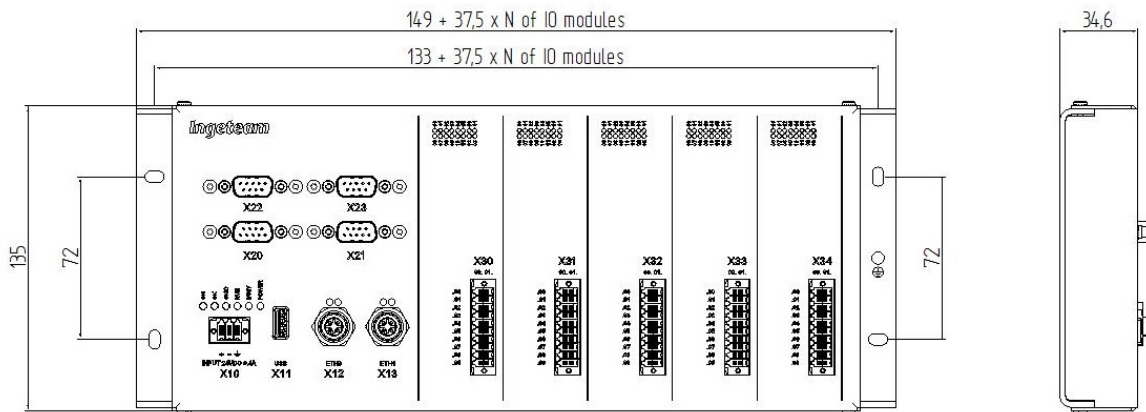

Fig 55. INGESYS™ IC2 Dimensions.

Maximum I/Os modules	Max. 10 x I/O modules for Controller Max. 8 x I/O modules for Remote I/O
Processor or Header module dimensions	149mm x 135mm x 34,6mm
I/O modules dimensions	37,5mm x 135mm x 34,6mm
Mounting	Panel
Case material	Aluminium
Weight	360gr + (100gr x No. of I/O modules) + (20gr x No. of field-bus modules)

Tbl 73. Mechanical data.

Use Conditions & Standards

5 Use Conditions & Standards

The **INGESYS™ IC2** presents two variants differentiated in the fulfillment of specific sector standards.

The **INGESYS™ IC2** variant for Rolling stock control, designed by the code **R** in the product reference (IC2-X-R-XXX-X-XXXXXXXXXX), is compliant with European directives CE and with railway standard EN50155.

The **INGESYS™ IC2** variant for Industrial sector, designed by the code **I** in the product reference (IC2-X-I-XXX-X-XXXXXXXXXX), is compliant with European directives CE and with the railway standard EN50155, except in the compliance of power supply voltage range defined by this standard.

5.1 Climatic

INGESYS™ IC2 system environmental limits:

Climatic Conditions	
Temperature Range	-40°C to +70°C (EN50155:2017 OT4)
Relative Humidity Range	30% to 95% (EN50155:2017 Damp Heat Cyclic Test)

Tbl 74. Climatic Conditions.

Pollution degree 2, Class III system supply, Altitude up to 2000m, Overvoltage Cat. II, Indoor use, Intended to be mounted/installed in cabinet or enclosure prevent against mechanical, fire and electric shock hazard.

5.2 Storage and Transport

The “Storage and Transport Conditions” table below details the terms for storing and transporting **INGESYS™ IC2** system in their original packaging:

Storage and Transport Conditions	
Vibrations	Check Vibration and Shock Tests
Shocks	Check Vibration and Shock Tests
Temperature Range	-40°C to +90°C
Relative Humidity Range	10% to 95%

Tbl 75. Storage and Transport Conditions.

5.3 Electromagnetic Compatibility

INGESYS™ IC2 system complies with European directive 2004/108/CE on electromagnetic compatibility (EMC) as well as the EN50155 Railway Standard. The following table shows the approved standards tests and the levels applied:

Test	Standard Applied	Test Level
Power Supply Compliance Tests	EN 50155:2017	Class S1/C1 (only in INGESYS IC2-X-R-XXX-X-XXXXXXXXX variant)
Electric Shock Immunity Tests	EN 61000-4-2 EN 50121-3-2:2016+A1:2019	Shock on contact: ±6kV Shock in the air: ±8Kv
Radio-frequency, radiated, electromagnetic field immunity tests	EN 61000-4-3 EN 50121-3-2:2016+A1:2019	20V/m / 80MHz – 1Ghz 10V/m / 1,4GHz – 2,1GHz 5V/m / 2,1GHz – 2,5GHz
Rapid transient bursts immunity tests	EN 61000-4-4 EN 50121-3-2:2016+A1:2019	±2kV (signal) ±2kV (DC power supply)
Shock wave immunity tests	EN 61000-4-5 EN 50121-3-2:2016+A1:2019	±2kV line to earth ±1kV line to line
Immunity against conducted disturbances induced by radio-frequency fields	EN 61000-4-6 EN 50121-3-2:2016+A1:2019	10Vrms
Radiated emission measurement	CISPR 16-2-3 EN 50121-3-2:2016+A1:2019	50dB (µV/m) between 30MHz and 230MHz, 57dB (µV/m) between 230MHz and 1000MHz
Conducted emission measurement	CISPR 16-2-3 EN 50121-3-2:2016+A1:2019	99dB (µV/m) between 0,15MHz and 0,5MHz, 93dB (µV/m) between 0,5MHz and 30MHz
Insulation Test	EN 50155:2017	Insulation resistance: 500Vdc Dielectric Strength: 500Vac / 710Vdc

Tbl 76. Summary of EMC tests.

5.4 Vibration and Shock

INGESYS™ IC2 system has passed the following vibration and shock tests according to EN50155, certifying its reliability.

Vibrations Test		
Constant frequency	Frequency Severity Duration	15Hz 28,9m/s ² 4,5hours on each axis (x,y,z)
Frequency scan	Range Severity Duration	From 3Hz to 100Hz See Frequency Scan Test 4,5hours on each axis (x,y,z)

Tbl 77. Vibrations Test.

Shocks Test	
Shock type	1/2 sinusoidal wave cycle
Acceleration peak/pulse duration	15g / 11ms
Number of pulses	3 successive pulses in each direction (+ & -) and per axis (x,y,z) = 3x2x3 = 18pulses

Tbl 78. Shocks Test.

Frequency Scan Test									
Frequency (Hz)	5	11	18	20	30	32	50	60	100
Ax, Ay, Az (m/s ²)	2	11	11	20	20	14	14	10	10

Tbl 79. Frequency Scan Test.

INGESYS™ IC2 system has also been designed to conform to the following vibration tests as stated in EN50155 (IEC 61373:2010):

Vibrations Test		
Random vibration tests	Frequency Duration Severity: ASD Level ((m/s ²) ² /Hz) RMS Value (m/s ²)	5 to 150Hz 10min on each axis (x,y,z) Vertical :0,0301;Transversal 0,0144;Longitudinal 0,0144 Vertical: 1,01; Transversal: 1,01; Longitudinal: 1,01
Simulated long-life testing	Frequency Duration Severity: ASD Level ((m/s ²) ² /Hz) RMS Value (m/s ²)	5 to 150Hz 5h on each axis (x,y,z) Vertical: 0,964;Transversal: 0,461;Longitudinal: 0,461 Vertical: 5,72;Transversal: 5,72; Longitudinal: 5,72
Shock tests	Waveform Number of pulses Severity: Peak Accel (m/s ²) Duration (ms)	Half-sine pulses 3 positive and 3 negative successive pulses in each axis 50 30

Tbl 80. Vibrations Test as stated in EN50155 (IEC 61373:2010).

5.5 Fire Protection

INGESYS™ IC2 system fulfills the fire protection requirements defined in the standard EN455-45-2.



Test	Standard Applied	Test Level
Fire Protection on Railway Equipment	EN 45545-2:2013+A1:2015	HL2

Tbl 81. Summary of Fire Protection (EN45545-2) tests.

5.6 Cabling

Note:

Use copper conductors only.

Cable Type	Min. Section	Max. Section	Specification
Solid, min. H05(07) V-U	0.14 mm ²	1.5 mm ²	Temperature rating 90°C
Flexible, min. H05(07) V-K	0.14 mm ²	1.5 mm ²	Temperature rating 90°C
With plastic collar ferrule, DIN 46228 pt 4 	0.14 mm ²	1 mm ²	Wire-end ferrule w/plastic collar DIN 46228/4 or Weidmüller colour code <ul style="list-style-type: none"> • 1.00mm² [H1.0/18D] mtl. ferrule leng. 12mm, stripping leng. 15mm • 0.75mm² [H0.75/18D] mtl. ferrule leng. 12mm, stripping leng. 14mm • 0.50mm² [H0.5/16D] mtl. ferrule leng. 10mm, stripping leng. 12mm • 0.34mm² [H0.34/12] mtl. ferrule leng. 8mm, stripping leng. 10mm • 0.25mm² [H0.25/12] mtl. ferrule leng. 8mm, stripping leng. 10mm • 0.14mm² [H0.14/12] mtl. ferrule leng. 8mm, stripping leng. 10mm Temperature rating 90°C
Wire end ferrule, DIN 46228 pt 11 	0.14 mm ²	1.5 mm ²	Wire-end ferrule w/o plastic collar acc. to DIN 46228/1 <ul style="list-style-type: none"> • 1.50mm² [H1.5/10] mtl. ferrule leng. 10mm, stripping leng. 10mm Temperature rating 90°C

Tbl 82. Maximum Conductor Sections.

INGESYS™ IC2 Selection Table

6 INGESYS™ IC2 Selection Table

INGESYS™ IC2 can be configured based on particular needs. Up to 4 fieldbuses and up to 10 I/O modules can be selected.

The following rules apply when configuring a commercial reference:

Optional Fields

- Should be left blank if not used

Field Bus

- Selected from X20 to X23. Not used modules should be indicated with an X
- Several Notes apply to this kind of modules due to construction restrictions

IO modules

- Up to 10 modules can be selected. Complete only used modules (the rest will be left blank)
- Double width modules occupy two places, reducing total amount of modules
- Selection will be done in alphabetical incremental order from X30 (exceptions marked in Notes)
- When no IO module is selected, Terminals field should be left blank

Extra Field Bus

- When used, maximum number of IO modules is limited to 9

UL Certified modules

- UL certified modules are indicated in "Cert." column. Any combination of UL certified modules will result in a UL certified reference

Customizations

- Custom cover: monolithic case cover. Available for quantities above 20 units
- Contact with Sales Department for possible customization options

Specific commercial reference is obtained using the following selection table:

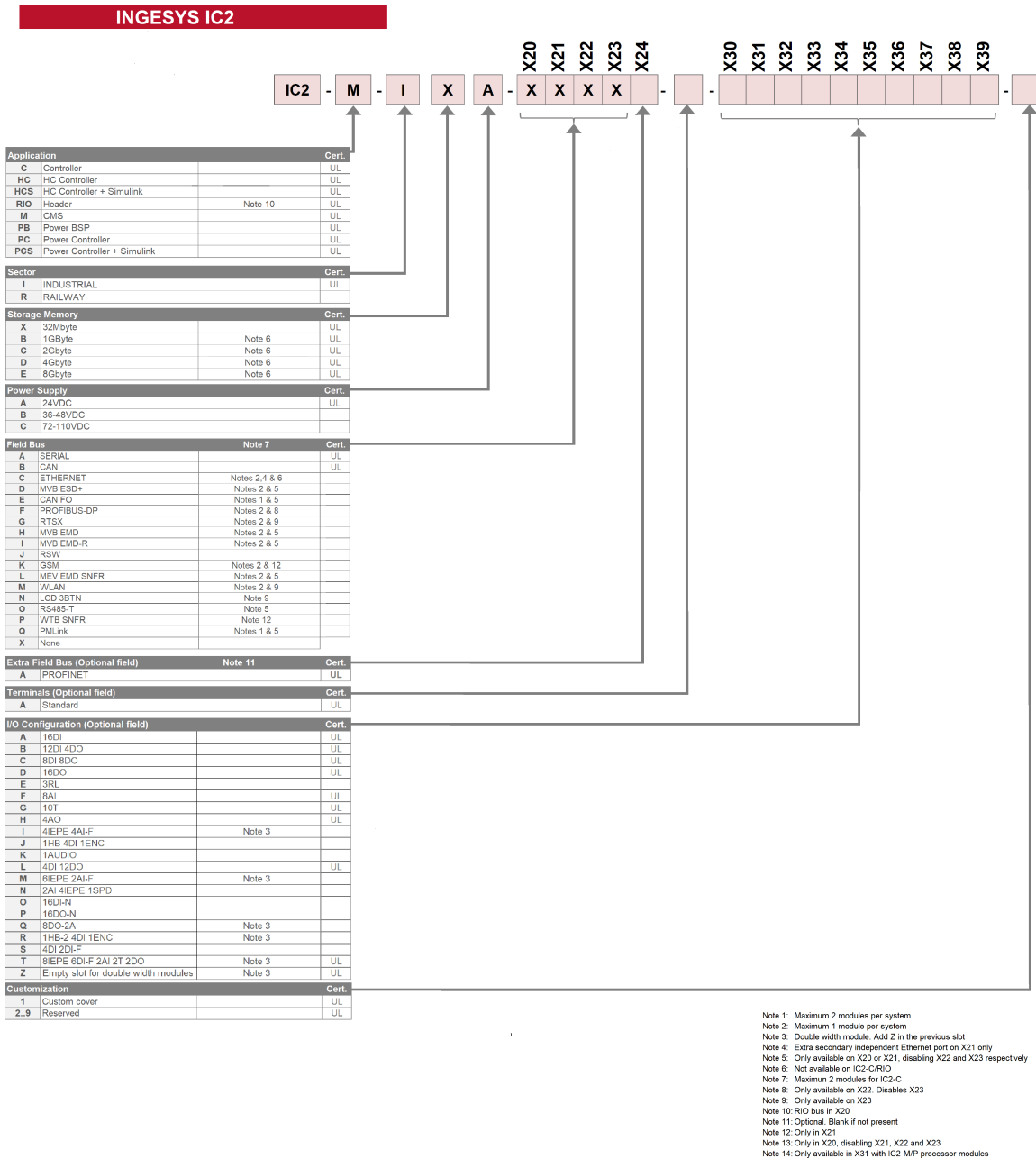

Fig 56. Selection Table.

Special Treatments:

COATING

- Industrial version (add "-2C" to the commercial reference)
- Railway version (is coated by default)

Note 1: Maximum 2 modules per system
 Note 2: Maximum 1 module per system
 Note 3: Double width module. Add Z in the previous slot
 Note 4: Extra secondary independent Ethernet port on X21 only
 Note 5: Only available on X20 or X21, disabling X22 and X23 respectively
 Note 6: Not available on IC2-CRIO
 Note 7: Maximum 2 modules for IC2-C
 Note 8: Only available on X22. Disables X23
 Note 9: Only available on X23
 Note 10: RIO bus in X20
 Note 11: Optional. Blank if not present
 Note 12: Only in X21
 Note 13: Only in X20, disabling X21, X22 and X23
 Note 14: Only available in X31 with IC2-MIP processor modules

Revisions

7 Revisions

ID	Date	Description	Chapter
H	2023-09-28	High Power DC Motor Control pinout fixed	2.6 -Input / Output's Modules

Tbl 83. Revisions.

Total or partial reproduction of this publication by any means or procedure is prohibited without previous express written authorisation by Ingeteam Power Technology.

One of the primary goals of Ingeteam Power Technology is the continuous improvement of its equipment; consequently, the information contained in this catalogue may be modified without previous notice.

For further information, please refer to the manual or contact us.

Parque Tecnológico de Bizkaia-Edificio 110

48170 Zamudio (Bizkaia)

Tel +34-944 039 600

Fax +34-944 039 679

ingesysic.support@ingeteam.com

www.ingeteam.com

Ingeteam